

Visualiner Series

Operator's Manual

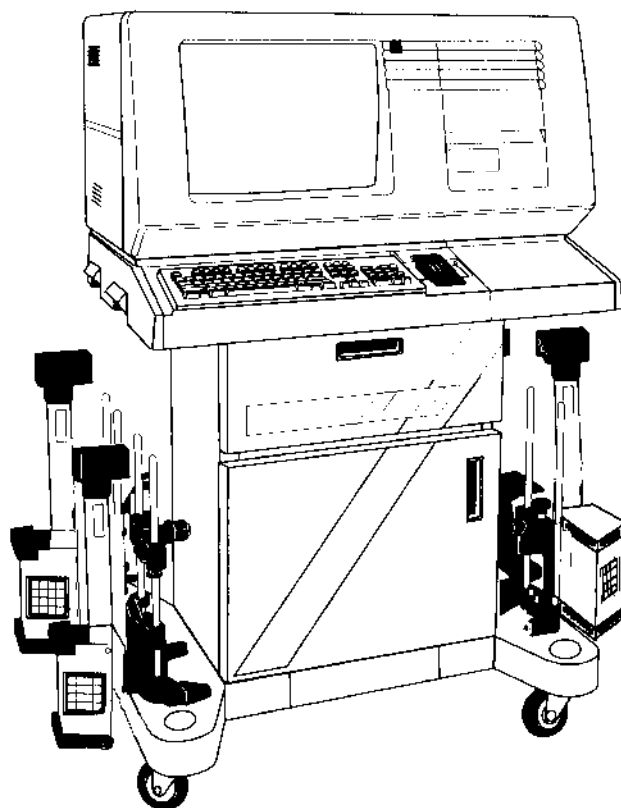

John
BEAN
Company

*The Leader in
Alignment Technology
Since 1925*

FORM 5021-7

(Blank Page)



309 Exchange Avenue
Conway, AR 72032 USA
(501) 450-1500

Visualiner Series

Wheel Aligner

Operator's Manual

Print History

Current Edition

Form #5021-7

October 1997

Copyright Statement

This manual and the materials contained within are the property of John Bean Company, a division of Snap-on Incorporated. The manual, or any section, page, drawing, or screen capture, may not be reproduced by any means without the written consent of John Bean Company.

(Blank Page)

SAFETY INFORMATION

**For your safety, read this manual thoroughly
before operating the Visualiner Series Aligner**

The Visualiner Series Aligner is intended for use by properly trained, skilled automotive technicians. The safety messages presented in this section and throughout the manual are reminders to the operator to exercise extreme care when performing wheel alignments with this product.

There are many variations in procedures, techniques, tools, and parts for servicing vehicles, as well as the skill of the individual doing the work. Because of the vast number of vehicle applications and potential uses of the product, the manufacturer cannot possibly anticipate or provide advice or safety messages to cover every situation. It is the automotive technician's responsibility to be knowledgeable of the vehicle to be aligned. It is essential to use proper service methods and perform wheel alignments in an appropriate and acceptable manner that does not endanger your safety, the safety of others in the work area or the equipment or vehicle being serviced.

It is assumed that, prior to using the Visualiner Series Aligner, the operator has a thorough understanding of the vehicle systems being serviced. In addition, it is assumed he has a thorough knowledge of the operation and safety features of the alignment rack or lift, and has the proper hand and power tools necessary to perform wheel alignments.

When using your garage equipment, basic safety precautions should always be followed, including:

1. Read all instructions.
2. Care must be taken as burns can occur from touching hot parts.
3. Do not operate equipment with a damaged power cord or if the equipment has been dropped or damaged until it has been examined by a qualified serviceman.
4. Do not let cord hang over edge of table, bench or counter or come in contact with hot manifolds or moving fan blades.
5. If an extension cord is necessary, a cord with a current rating equal to or more than that of the equipment should be used. Cords rated for less than the equipment may overheat. Care should be taken to arrange the cord so that it will not be tripped over or pulled.
6. Always unplug equipment from electrical outlet when not in use. Never use the cord to pull the plug from the outlet. Grasp plug and pull to disconnect.
7. Let equipment cool completely before putting away. Loop cord loosely around equipment when storing.
8. To reduce the risk of fire, do not operate equipment in the vicinity of open containers of flammable liquids, such as gasoline.
9. Adequate ventilation should be provided when working on operating internal combustion engines.
10. Keep hair, loose clothing, fingers, and all parts of body away from moving parts.
11. To reduce the risk of electrical shock, do not use on wet surfaces or expose to rain.
12. Use only as described in this manual. Use only manufacturer's recommended attachments.
13. **ALWAYS WEAR SAFETY GLASSES.** Everyday eyeglasses only have impact resistant lenses, they are **NOT** safety glasses.

IMPORTANT !! SAVE THESE INSTRUCTION -- DO NOT DISCARD !!

SAFETY INSTRUCTIONS

IMPORTANT!! SAVE THESE INSTRUCTIONS



Risk of electrical shock.

- Do not operate equipment with a damaged power cord or if the equipment has been dropped or damaged, until it has been examined by a qualified service person.
- If an extension cord is necessary, a cord with a current rating equal to or greater than that of the equipment should be used. Cords rated for less current than the equipment can overheat.
- Unplug equipment from electrical outlet when not in use. Never use the cord to pull the plug from the outlet. Grasp plug and pull to disconnect.
- Do not expose the equipment to rain. Do not use on wet surfaces.
- Plug unit into correct power supply.
- Do not remove or bypass grounding pin.

Contact with high voltages can cause death or serious injury.



Risk of electrical shock. High voltages are present within the console unit.

- There are no user serviceable items within the console other than the keyboard and printer.
- Service on the unit must be performed by qualified personnel.
- Do not open any part of the console other than noted areas.
- Turn power switch off and unplug the unit before servicing.

Contact with high voltages can cause death or serious injury.



Risk of eye injury. Debris, dirt, and fluids may drop from vehicles.

- Knock off any loose debris. Clean surfaces as needed to avoid any materials from falling.
- Wear approved safety glasses when servicing.

Debris, dirt, and fluids can cause serious eye injury.



Risk of crushing. Vehicles may roll off alignment lift if not secured.

- Leave automatic transmission in park or manual transmission in gear unless equipment operation steps require vehicle in neutral.
- Apply parking brake unless equipment operation steps require wheel movement.
- Use wheel chocks whenever vehicle is positioned on the lift.
- Follow rack or lift manufacturer's safety recommendations when lifting a vehicle.

Vehicles rolling off lifts can cause death or serious injury.



Risk of entanglement or crushing. There are moving parts on vehicle lifts during operation.

- **Keep all persons clear of lifts.**
- **Read lift manufacturer's operation instructions carefully.**
- **Follow lift manufacturer's safety recommendations.**

Contact with moving parts could cause injury.



Risk of pinching or crushing body parts when jacking vehicles.

- **Keep hands and other body parts away from jacking surfaces.**
- **Do not use unapproved adapters (i.e. wooden blocks) when jacking a vehicle.**
- **Do not bypass any jack manufacturer's safety features.**
- **Read jack manufacturer's operation instructions carefully.**
- **Follow jack manufacturer's safety recommendations.**

Improperly used or maintained jacks can cause injury.



Risk of burns.

- **Do not touch hot exhaust systems, manifolds, engines, radiators, etc.**
- **Wear gloves whenever performing a service near hot components.**

Hot components can cause burns.



Risk of injury. Tools may break or slip if improperly used or maintained.

- **Use the correct tool for the task.**
- **Frequently inspect, clean, and lubricate (if recommended) all tools.**
- **Follow recommended procedures when performing vehicle services.**

Tools that break or slip can cause injury.

(Blank Page)

Table of Contents

	Page		Page
1. Getting Started			
Introduction	15	Customer Data	50
Assembly & Setup	17	Vehicle Specifications Entry	51
Aligner Location	17	Illustrate Adjustment	52
Power On	17	Edit Specifications	52
Aligner Components	18	Inspection Menus	53 - 55
Console	18	Runout Compensation	56 - 57
Computer Connections	19	Caster Measurement	58 - 59
Measuring Heads	20	Advanced Diagnostics - Bent Parts	60
Wheel Clamps	21	Rear Alignment Readings	61
Navigation	22	Soft-keys	61
2. Setup Guide		Zoom	62
Setup Menu	26	Front Alignment Readings	63
Help ?	26	Illustrations & Animated Graphics	64
Setup Flowchart	28	All Readings	65
Customizing Aligner	28	Measuring Other Angles	66
Rack / Floor	28	SAI Measurement	67
System Configuration	28	Toe Out On Turns	68
Head Selection	29	Maximum Turn Angle	69
Keyboard	29	Toe Curve Change	69
Turntables	29	4 Wheel Steering	69
Printer Selection	30	Setback / Vehicle Dimensions	70
Paper Selection	30	Adjustment Assistant	71
Software Configuration	31	A-Arm Adjust	71
Customize Interaction	31	Live Caster and Camber	72
Alignment Order	31	Camber Elevated	72
Skip Allowed	32	Drag Link	73
Displays	32	Shim Information	74
Cross Values Selection	32	EZ Shim Program	74
Shim Manufacturer Select	33	Cradle Alignment	75
Advanced Driver Complaint	34	EZ Toe	76
Setback/Dimensions	34	Driver Complaint Menu	77 - 79
Calibration Check	34	Printer Menu	79
Threshold Setting	34	Glossary of Alignment Terms	81 - 83
Optional Alignment Styles	35	4. Files and Customer Database	
Caster/Camber @ 0 Toe	35	Files Menu	87
Thrust Alignment Only	35	Customer Database	87
All Readings Position	36	View Customer Records	88
Language	37	Select Disk Drive	89
Vehicle Spec Selection	37	Backup/Restore Database	89
Units of Measure	38	Using Database in Alignment	90 - 92
Toe Units	38	Store Name	93
Angle Units	39	Mitchell	93
Linear Units	39	5. Maintenance and Service	
Resolution	39	Maintain Aligner	97
Date/Clock	40	Calibration	99
3. Operation Instructions		Camber, SAI, Cross Toe	100
Introduction	45	Track Toe	101
Performing a 4 Wheel Alignment	47	Calibration Factors & History	103
Attach Wheel Clamps	48	Measurement Data Display	104
Main Menu	49	Aligner Diagnostics	105
Begin Alignment Menu	49	User Serviceable Parts	106
		Troubleshooting Problems	107 - 109

(Blank Page)

Introduction

This manual is designed to give installation, operational, and maintenance information for the Visualiner Series Alignment system.

The Visualiner Series is the most advanced alignment system on the market today and is designed to give many years of profitable service. As with any piece of equipment, proper maintenance of the system will help keep the Visualiner operating at peak performance.

The John Bean Visualiner is designed for easy operation and maintenance. Three major components make up the system.

The first, and the one less obvious, is the computer microprocessor, electronics, and software used to provide the Visualiner with fast and accurate readings. These items are located in the console assembly and require very little operator interaction or maintenance. The console also provides storage for the measuring heads, a drawer for the optional printer, and storage in the lower cabinet.

The second component is the SVGA monitor display and operator control systems. Located in the console assembly, the Visualiner is available with 19" or 14" monitors. Control and operation of the unit is done through interaction with the software on the remote control unit, the head keypads, or the optional console keyboard.

The third part of the system consists of the measuring heads and wheel clamps. The heads attach to the wheels and contain advanced electronic sensors for measuring all wheel alignment angles. The heads and clamps are designed to be versatile, durable, and easy to use. The heads require periodic maintenance and calibration to keep the Visualiner at peak operating condition.

Thank you for purchasing the Visualiner Series Alignment system. We at John Bean Company are confident that you will enjoy the many years of profitable service and are available to serve your equipment needs. Refer to the back page of this manual for John Bean Company facilities worldwide or contact your local John Bean Company Distributor or Representative.

(Blank Page)



Visualiner Series

Getting Started

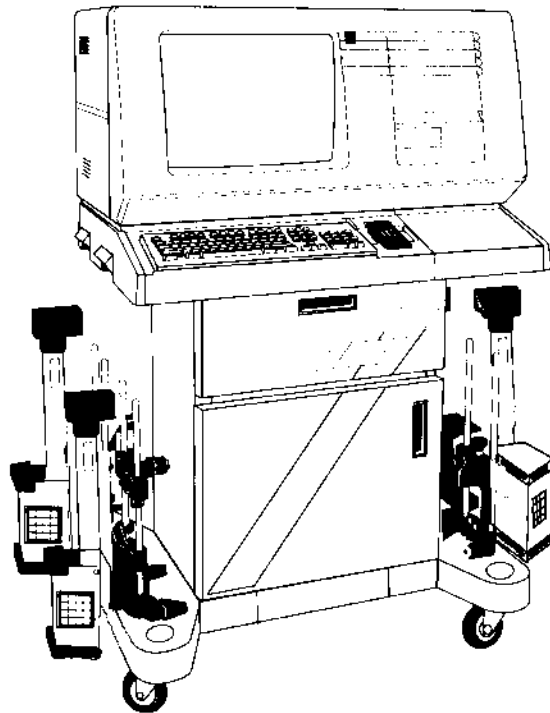

(Blank Page)

Introduction

This section is designed as a starting point for owners and operators of the Visualiner Model V6 and V7 Aligners. The Visualiner software provides a powerful tool for service centers who offer wheel alignment services. The setup, operation, and maintenance of the Visualiner is covered in sections 2 - 5. The first part of this section describes what is necessary to get started using the Aligner. The components of the system are described, and navigation through the software is shown.

The Visualiner requires a very specific set of computer hardware components. All these components are integrated together to optimize the speed and functionality of the software. Substitution of these items, or the addition of any other computer components to the aligner, could compromise proper operation and is not recommended. Consult John Bean Company Technical Support prior to performing any changes to the hardware configuration.

The Visualiner program is DOS-based, with the bulk of the program residing on a CD-ROM. Do not manipulate, change, or copy any files or system configurations unless qualified to do so. The aligner may not operate properly if unauthorized changes have been made.

Thank you for purchasing the John Bean Visualiner system. We at JBC are confident this state of the art alignment machine will provide many years of profitable service. Should any additional assistance or information be required, call the following number in the USA:

1-800-362-8326
or
1-501-450-1500

John Bean Company is a registered trademark of Snap-on Incorporated.

(Blank Page)

Getting Started

The Visualiner offers extraordinary power and versatility. With proper setup, operation, and maintenance, the system will provide many years of profitable service. This section of the manual describes how to begin enjoying the many features and benefits of the Aligner. References are often made to other sections of the Visualiner Operator's Manual .

Assembly and Setup

Installation and setup of a new Visualiner is best handled by a qualified John Bean Company Representative. If unsure of who to contact, refer to the back of this manual.

The aligner must be calibrated to at least one rack, lift, or other surface where wheel alignments are to be performed.

The Compact Disc that contains the alignment software should be placed into the CD-ROM drive prior to software loading. Leave the software Compact Disc in the CD-ROM drive unless the on-screen instructions say otherwise.

Instructions for operational setup of the Visualiner program are covered in detail in Section 2 of this Owner's Manual. The setups for the PC hardware and MS-DOS are preset at the factory and should not be altered.

All the software in the Visualiner Series is property of the respective companies who developed it. Unauthorized copies or distribution of these software products is strictly prohibited by federal law.

Aligner Location

Each shop is unique. Locate the aligner in a location in the spot that provides the most convenience for the operator. Remember, visual contact with the monitor is necessary during most steps of a wheel alignment. Most shops position the aligner in front of the alignment lift, offset to either the left or right sides.

Power ON

The power switch for the Visualiner is located on the rear of the unit (see Figure 3 on Page 18). This switch turns on all of the aligner's components. Make sure the monitor's power switch and the computer's power switch (in lower cabinet) are left in the ON position at all times.

When the power switch is turned on, the unit initiates the computer bootup. The monitor flickers as the video system is loaded. Text should appear on the screen as bootup begins and counting numbers are shown as the memory of the unit is checked and verified. Many additional lines of computer configuration will appear on screen and scroll up as the computer completes the system boot sequence. The next screen display will be a bar graph that indicates the loading of the Visualiner Alignment program. Finally, after the software has loaded, the JBC Logo Screen will appear, followed by the Main Menu (Figure 1) when any key is pressed, indicating the Aligner is ready for operation. This boot sequence should take about two minutes. If any problems are encountered during the Power On bootup sequence, consult the Maintenance and Service section of this Owner's Manual.

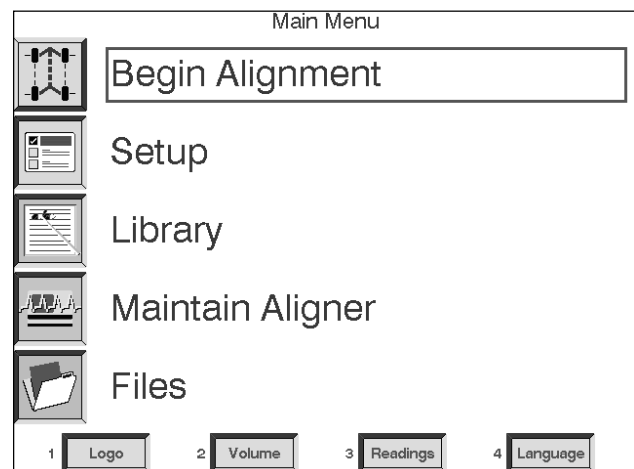

Figure 1 - Main Menu Screen

Aligner Components

Console

The console houses many of the aligner components including the power supplies, the computer system, the head interface components, and provides places for the display monitor, keyboard, and printer. The measuring heads are placed on the sides of the lower cabinet when not in use.

The upper portion of the console provides a location for the display monitor, computer system, and keyboard. The monitor has no external adjustments. The computer system is housed to the right side of the monitor. The front of the computer is accessed by a door that swings up and can be slid back. The computer has a front-mounted power switch that controls power to the entire system. The computer also contains a CD-ROM drive where the operating software is loaded, plus a floppy drive used for future use.

The lower part of the console has a printer drawer to keep the printer away from shop elements. The drawer is mounted on a slide mechanism to ease usage and paper replacement. The storage cabinet is used to store extra fanfold computer paper, and has other pockets for storing additional items.

NOTE: Be careful not to expose the aligner or measuring heads to water, heavy dust environments, or operations that produce metal chips. Do not block the rear of the computer or disable the cooling fan.

The main On/Off switch for the aligner is located behind the computer access door on the front of the aligner. The main power cable connects to the rear of the unit. Next to the plug are a series of protective fuses. In the event of a power overload, one or more of these fuses may blow, rendering the aligner unusable. Check the fuses whenever the unit is non-operational.

The head interconnect cables plug into the back of the console. There are 6 female connectors -- one for each of the 4 heads, one for the optional remote display unit, and one spare. When the aligner is utilized with a rack wiring kit, all 6 connectors are used. The connectors are universal -- it does not matter which head is plugged into any of the 6 connectors.

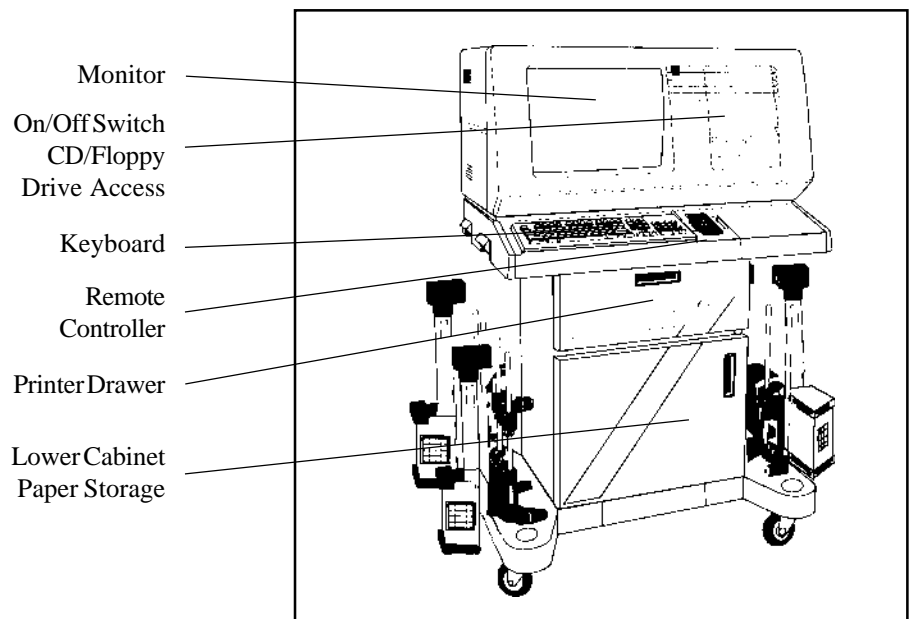

Figure 2. Visualiner Front View

Computer Connections

Installation of the Visualiner includes connection of devices to the computer. Should there be any reason to examine those connections, or change a component such as the printer, *Figure 3* illustrates the location on the back of the aligner for each connection.

CAUTION! There are no serviceable parts inside the computer. **DO NOT** attempt to open the computer case for any reason. Call for service if a computer problem is suspected.

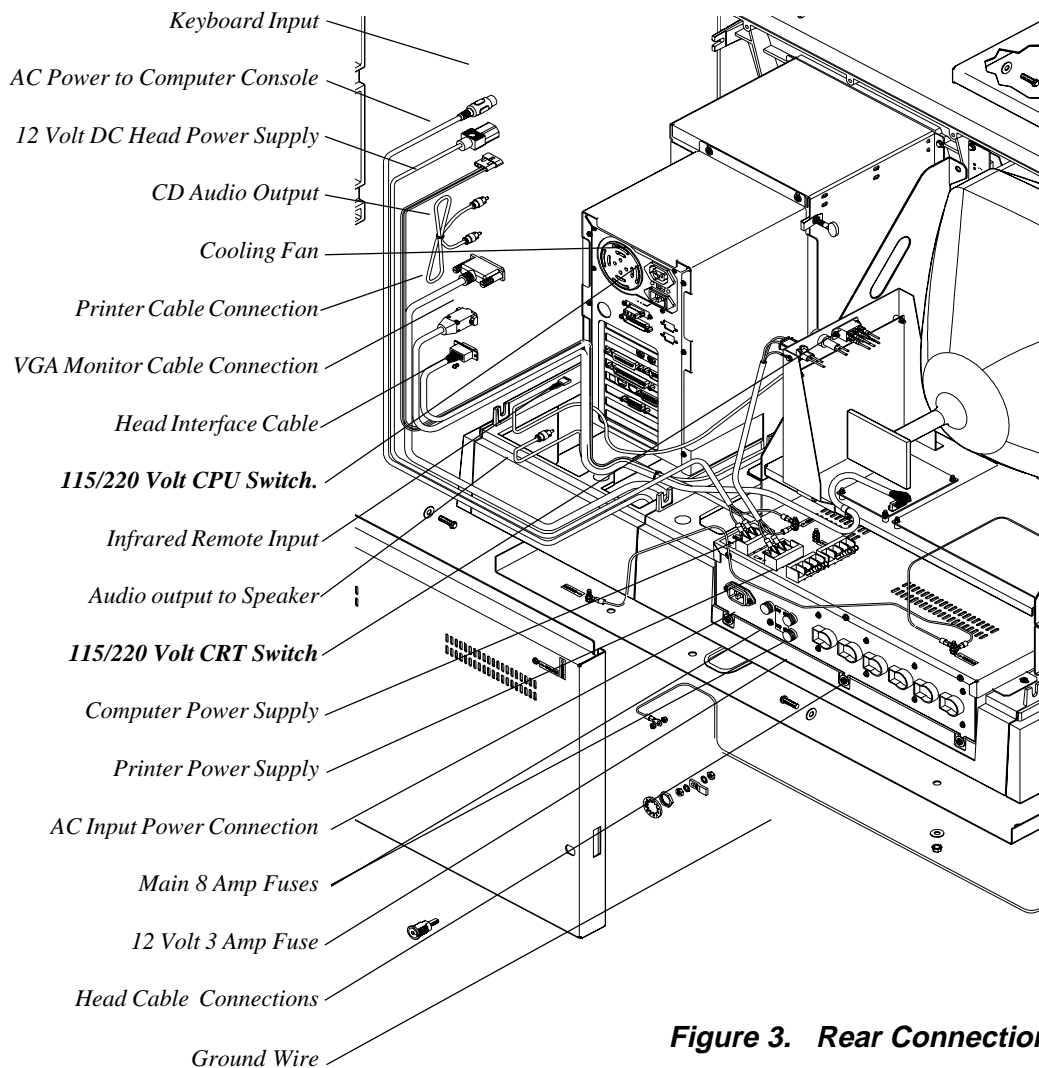

Figure 3. Rear Connections

WARNING ! DO NOT REMOVE THE REAR COVER UNLESS INSTRUCTED BY JOHN BEAN PERSONNEL. Remove power from the aligner prior to removing cover. Call for a certified John Bean Co. technician if you are in doubt as to how to make any connection. Making a connection incorrectly could damage the unit and void the warranty.

Measuring Heads

The operation of the Visualiner can be controlled at any of the measuring heads. Study *Figure 4* below to become familiar with the layout of the head keypads.

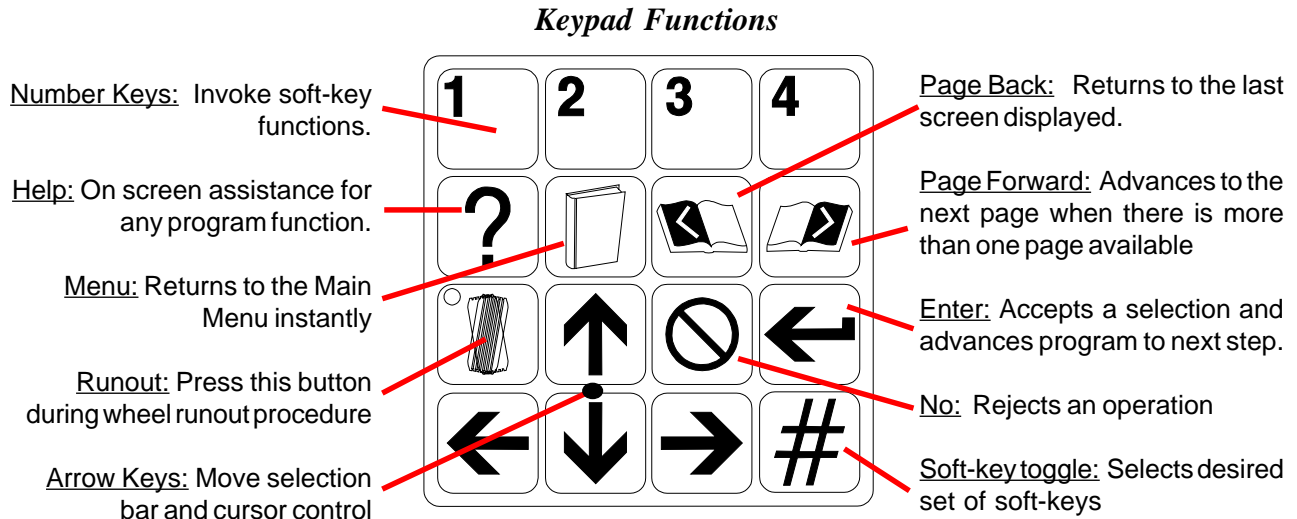

Figure 4

Figure 5 below shows some of the components of the Visualiner optical measuring heads.

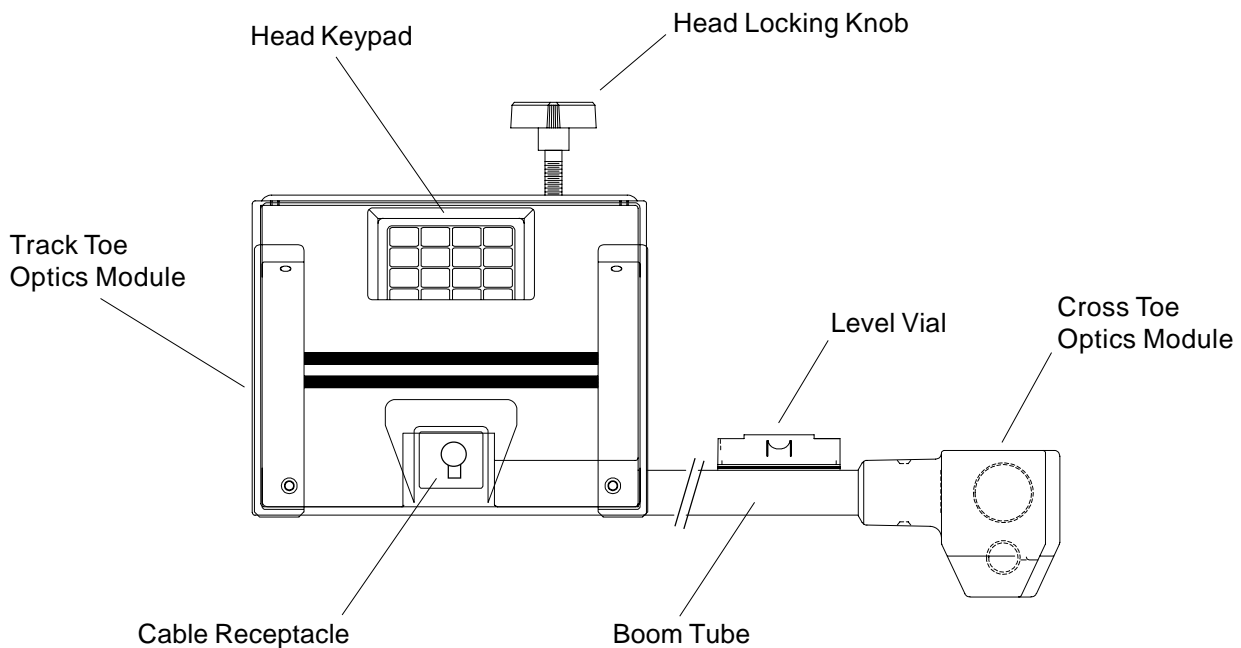

Figure 5 -- Head Components

Wheel Clamps

The wheel clamps allow for placement of the heads on a variety of vehicles. *Figure 6* identifies the components of the wheel clamp. See page 48 of this manual for instructions on how to attach the clamp to various wheels.

Notice the wheel clamps are adjustable to different wheel sizes by moving the upper and lower brackets. The center slide bracket can be moved to any position prior to wheel runout compensation, allowing for a clear line of site for the toe measurement system.

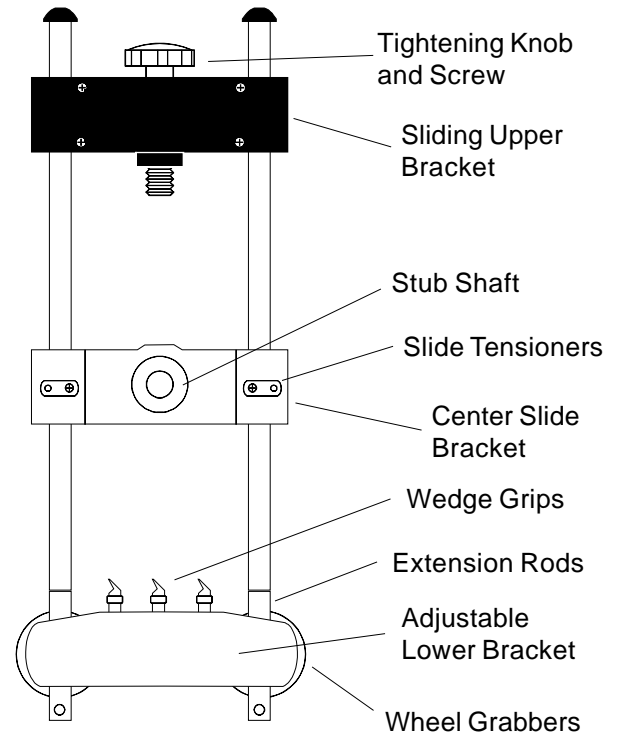

Figure 6

Navigation

Before we begin to explore the many features of the Visualiner let's become familiar with the basic navigation and operation of the aligner.

There are several ways to control movement within the aligner program. All Visualiner Series models are equipped with a hand-held remote control whose various buttons permit full aligner function. In addition, the measuring heads on all models are fitted with a keypad with the same button layout as the remote, allowing operation from any wheel (see *Page 20*). Models equipped with the optional remote display unit will also have a similar keypad. Study *Figure 7* carefully to become familiar with the functions of each button.

For Visualiner Series models equipped with the optional printer package, an IBM-style keyboard is included. All aligner functions can be controlled from the keyboard as well as the remote and the measuring heads. The function keys located on the top row of the keyboard are the equivalent of the remote and keypad buttons. Refer to the diagram for identification of the icons and their respective functions.

In addition, the optional keyboard has a "Print Screen" key. When this key is pressed the currently displayed screen will be captured and printed. The exception to this print screen function is the animation sequences on the CD-ROM software which cannot be printed.

Note: The numeric keypad located to the far right on the keyboard does not function in the Visualiner software.

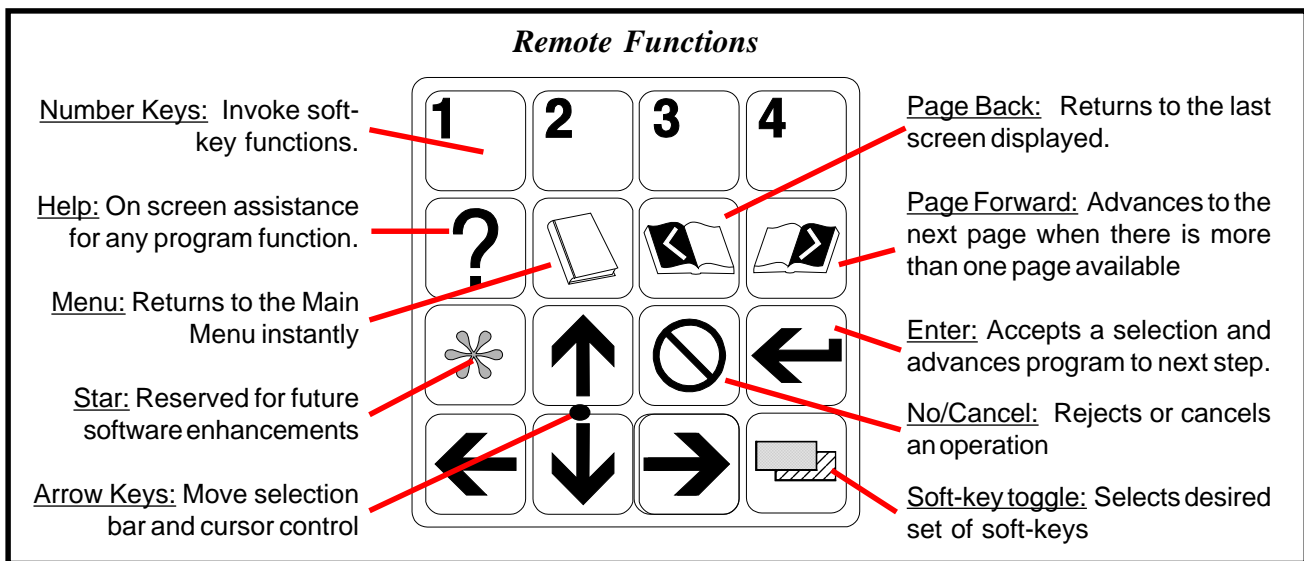
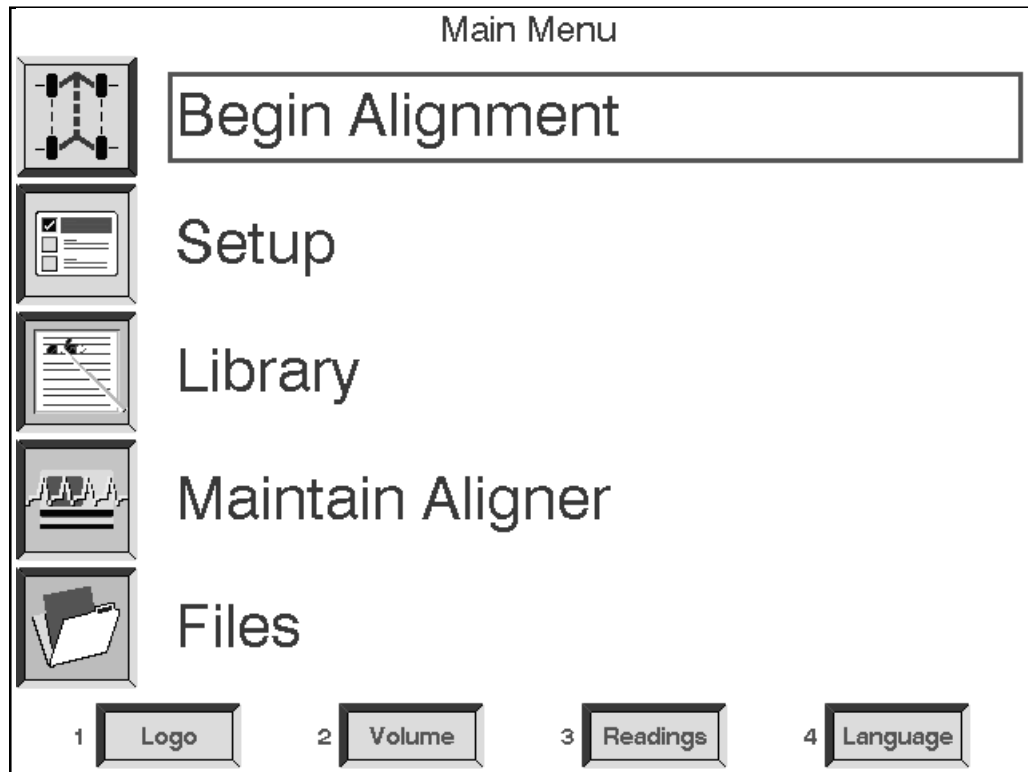

Figure 7 -- Visualiner Remote Control



The Visualiner Series software is "menu driven" for ease of use. Most of the screens allow choices to be made about which direction to go to access various functions. Menus with choices will always have a white selection box on the screen. When the selection box is positioned over a menu item using the up/down arrow keys and the Enter button is pressed, that item is activated.

Many areas of the software contain several layers of sub-menus to give the operator maximum control over the aligner's functions. Upon entering a selection on a menu, there may be additional selections on the sub-menu, and so on. When moving through the network of sub-menus the "Enter" button moves forward and the "Page Back" button moves backwards one page at a time. The "Menu" button can be pressed any time to return to the aligner's Main Menu screen shown above.

The Visualiner Series software also utilizes "soft-keys" to streamline operation and allow movement to additional functions. The soft-keys are located along the bottom of almost every screen in the aligner. Numbered 1 - 4, they correspond to the 1 - 4 keys on the remote and head keypad as well as the 1 - 4 function keys on the optional console keyboard. Press the keys on any location and the appropriate soft-key operation will begin.

(Blank Page)



Visualiner Series

Setup Guide

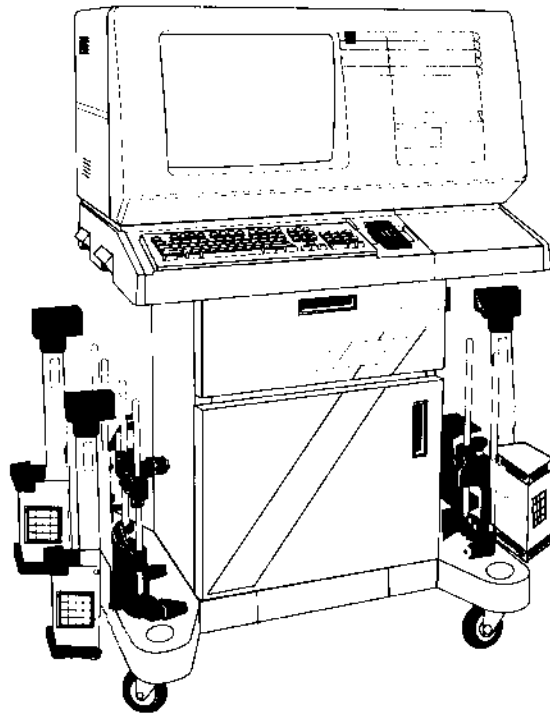

Setup

After the unit has successfully powered up it is necessary to give the computer some information about the way alignments will be performed. Configuration of the Visualiner Series takes only a few minutes. Many items are setup by the John Bean Representative who installs the aligner and will not need to be changed. Other items involve the flow of the alignment program and the access to certain functions that may need to be changed in the future depending on operator preference and the alignment and diagnostic routines necessary to properly service vehicles.

All setup items are accessed through the Setup item on the Main Menu. Upon entering the Setup Menu, there will be a series of additional menus and sub-menus for the various setup options. Consult the User Guide portion of this manual for instructions on how to use the various functions that can be enabled during the aligner setup. Consult the menu flow chart on Page 5 to locate the path for the desired function.

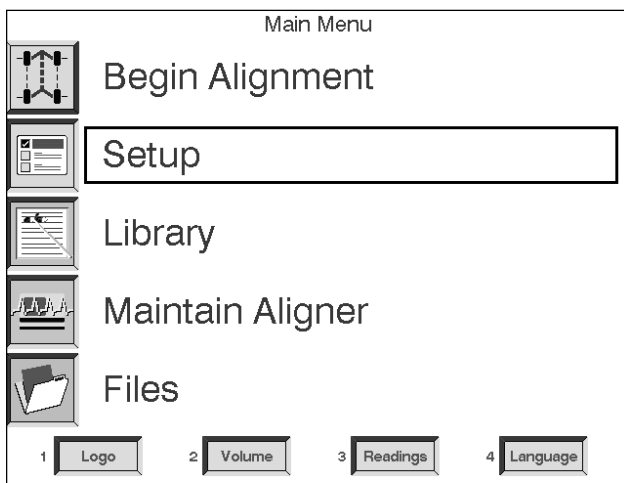

Here is a list of some of the things to tell the Visualiner before beginning to do alignments:

- Type of wheel alignments normally performed.
- The routine the operator is most comfortable with when performing an alignment.
- Which alignment rack or surface is to be utilized
- The units of measurement for toe, caster, camber, and others measurements
- Which software features are a part of the alignment program sequence
- The Language for the CRT display and the optional Printer.

To enter the Setup Menu, place the highlight box around Setup on the Main Menu and press the Enter button.

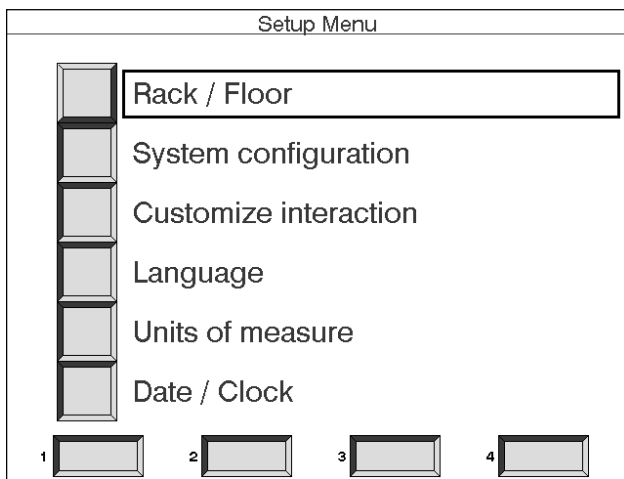

Setup Menu choices are:

Rack/Floor -- which one of 3 calibrated alignment surfaces will be utilized

System configuration -- setup of hardware items such as heads, keyboard, printer, etc.

Customize interaction -- allows the operator to tailor the program sequence and options as desired

Language -- certain software may allow the aligner to operate in languages other than English

Units of measure -- selection of units when toe, camber, caster, and other angles are displayed

Date/Clock -- for resetting the aligner's internal clock

HELP

Use the Help function should you require further assistance on Setup procedures. The Visualiner has a unique operator help system which is designed to provide instant access to information relative to the function being used. Use this any time you require further assistance by simply pressing the Help key.

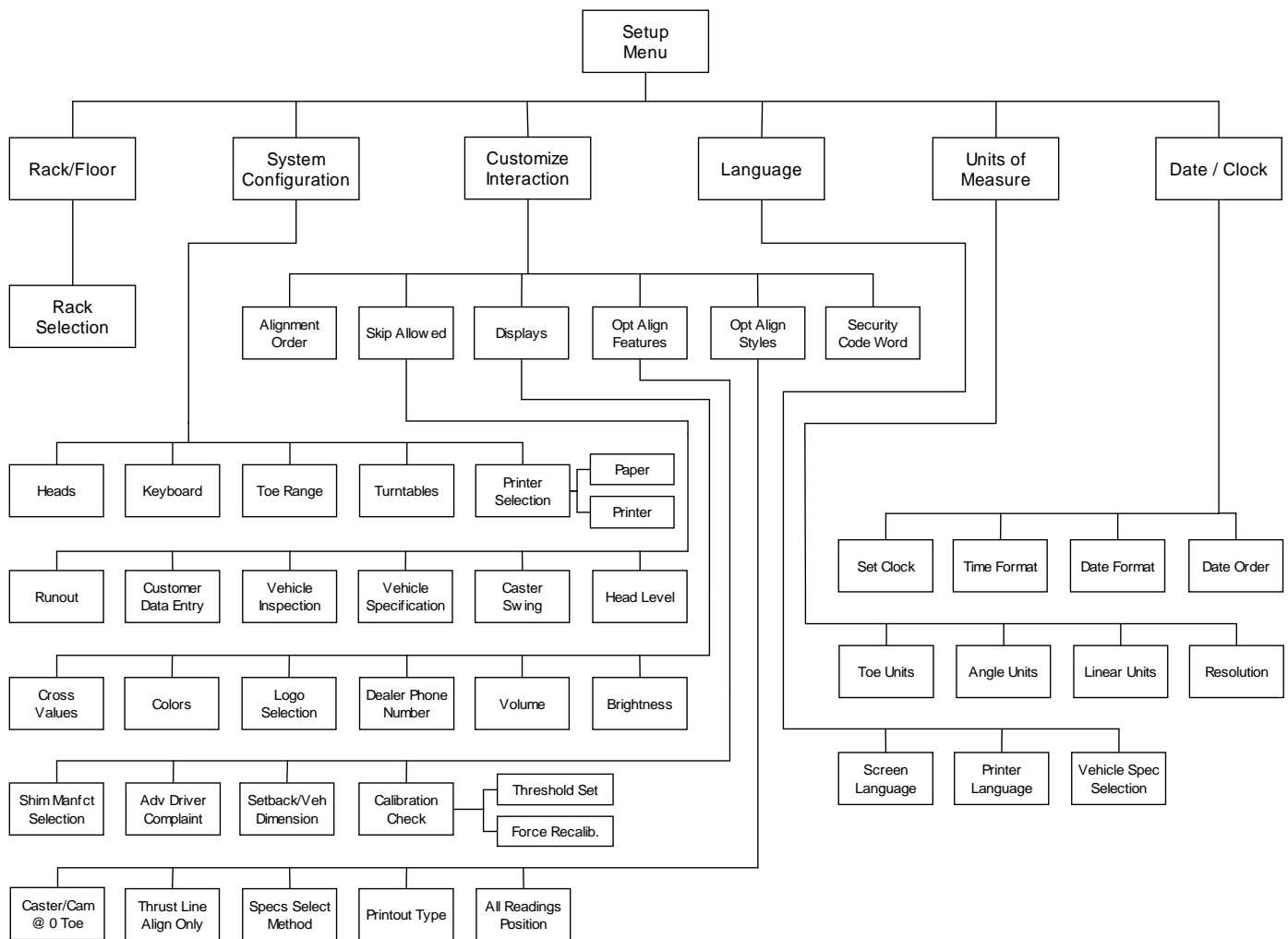

Setup Notes

- > Not all setup options are available with all software configurations.
- > Some setup items require a password for entry and are reserved for John Bean service personnel.
- > Many setup items are done once at the time of aligner installation and do not need to be changed. Others are software, user-interface related and may be changed depending on operator preference. Here is a list of setup items typically found in each category:

One Time, Upon Installation

Heads, Keyboard, Turntables, Printer, Skip items, Cross values, Colors, Logo, Dealer phone #, Calibration check, Specs select method, Printout type, Security code word

User Configuration Changes

Rack selection, Alignment order, Language, Units of Measure, Clock, Volume, Brightness, Shim man. select, Adv. driver complaint, Setback, Caster/Cam @ 0 toe, Thrust line only, All readings, Resolution

Customizing The Visualiner

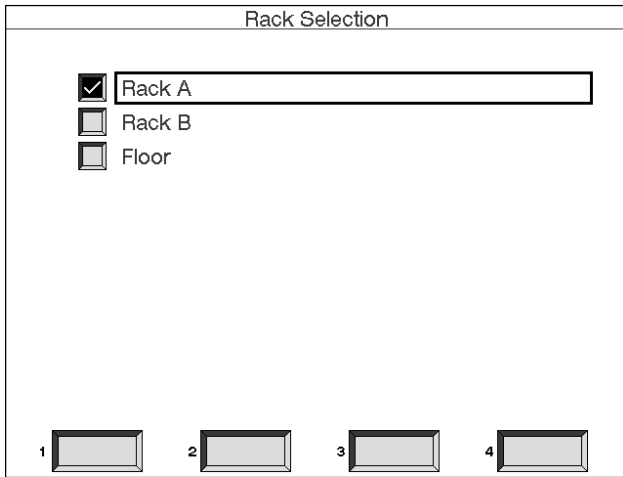

Once the Visualiner has powered up and the Main Menu is displayed an Alignment can be performed using the standard default settings. The following pages will assist in the setup and customizing of your new Visualiner Series Aligner.

1. Rack / Floor

The first item on the Setup Menu is used to select which of three calibrated alignment work surfaces are to be utilized. In most shops the primary alignment lift is designated as "Rack A".

Select the rack type used to perform most wheel alignments. Use the up/down arrow keys and press Enter when the choice is the one with the white box display around it. The rack choice may be changed whenever using a different surface for performing alignments.

Note: In order to perform accurate alignments, each lift/rack surface must be properly calibrated.

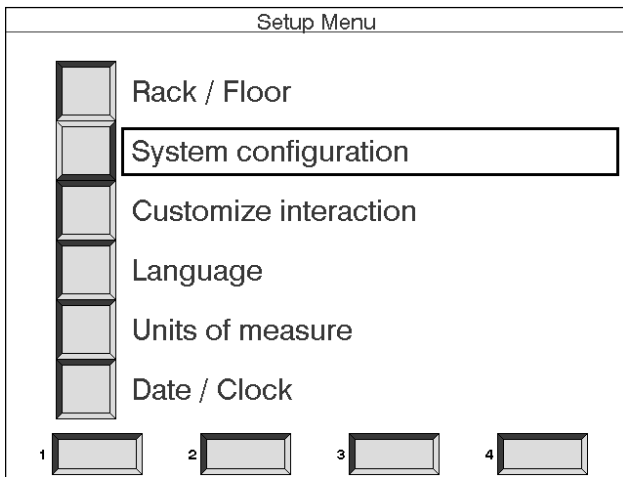

2. System configuration

The next item on the Setup Menu is used primarily to setup various hardware and system options. Place the highlight box around System configuration and press **ENTER**.

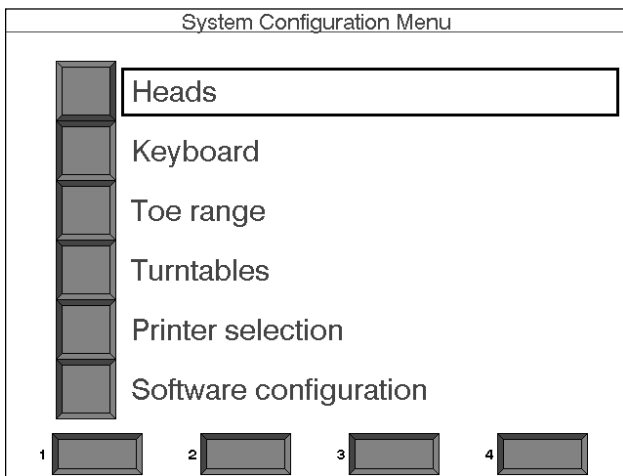

The System Configuration Menu choices are:

Heads -- selection of the various measuring head options offered for the Visualiner Series.

Keyboard -- which language will the optional IBM-type keyboard be used with.

Toe Range -- not utilized.

Turntables -- the selection for standard mechanical types or special optional electronic models.

Printer -- selection for the type of optional printer to be used with the Visualiner.

2a. Heads -- choose the measuring head configuration for the Visualiner model being set up. John Bean currently offers only optical measuring heads. Earlier models also offered toe-line (string) heads, with the difference being the type of technology used to measure the vehicle toe angles.

Optical Visualiner models are equipped with either 4 heads or 2 heads plus 2 retros. The 4 head units may have 6 toe sensors (beams going front/rear and across front) or 8 sensors (beams going front/rear, across front, and across rear).

When using 4 heads or 2 heads with retros, the Visualiner can perform either centerline, thrust, or complete 4 wheel alignments. The 2 head setup can be used to perform front total toe settings with either optical or string heads.

2b. Keyboard -- the Visualiner software supports keyboards designed for a variety of language applications. If such a keyboard is used, this is the place to go to change the configuration. Select the proper keyboard using the up/down arrow keys to scroll, then press Enter once the desired selection is checked.

2c. Turntables -- from the System Configuration Menu, place the highlight box over "Turntables" and press Enter. Most units will operate with standard mechanical-type turntables used on the front of the alignment lift. John Bean Company also offers Electronic Turntables to automate some measurements. Selections are:

Standard turntables -- mechanical-type utilized on most alignment lifts and racks (may be John Bean Company or another manufacturer).

Electronic turntables -- sophisticated specialized turntables containing electronic components to add additional capabilities.

Note: Do not select Electronic turntables unless lift is so equipped. Operational problems will be created if erroneously chosen.

Head Type Selection

- 4 Optical heads - 6 toe sensors
- 2 Optical heads - 2 retros
- 2 Optical heads
- 4 String heads
- 2 String heads - 2 hangers
- 2 String heads
- 4 Optical heads - 8 toe sensors

1234

Keyboard Selection

- Not Installed
- United States
- United Kingdom
- French
- German
- Danish
- Italian
- Spanish
- Flemish

1234

Electronic Turntable Selection

- Standard turntables
- Electronic turntables

1234

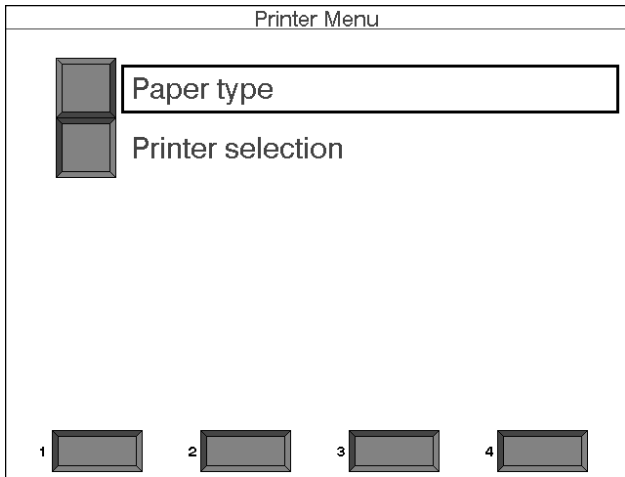

2d. Printer Selection -- if equipped with the optional Printer Package, from the System Configuration Menu choose "Printer selection". At this point a PrinterMenu screen appears with two setup choices:

Paper type -- select the size of paper to be used in the printer.

Printer selection -- what type of printer drivers are to be used by the program to generate printouts.

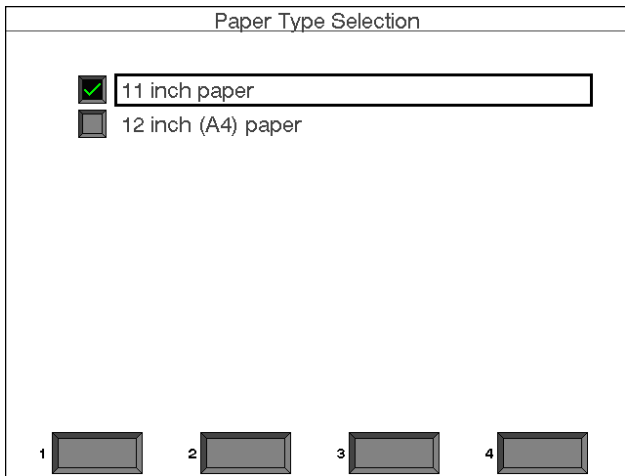

2d-i. Paper Type Selection -- the Visualiner software supports two different paper standards. The 11" size is the standard for the United States and North America, while A4 paper is the standard in Europe and many other parts of the world. If incorrectly set, paper feed length and printout margins will be affected.

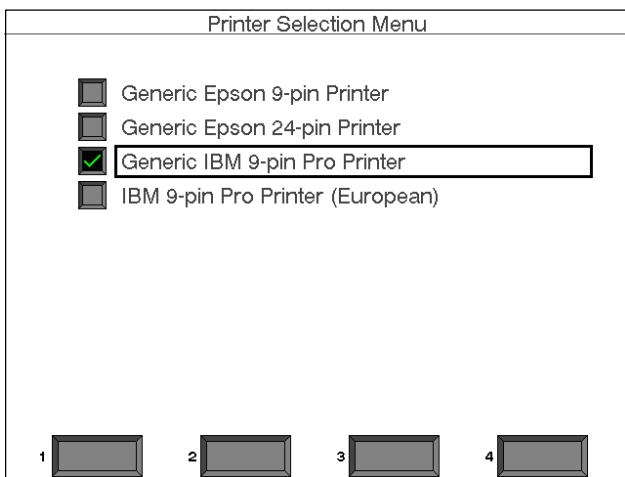

2d-ii. Printer Selection Menu -- the Visualiner supports either generic IBM or Epson 9-pin printer emulations plus the Epson 24-pin emulation for higher resolution printing. Most commercially available dot-matrix printers support one of these printer languages. If not, the printer will not function at all or will print illegible information. John Bean Co. always supplies a compatible printer with the optional printer kits. Select the proper printer based on the unit installed with the Printer Package.

2e. Software Configuration Menu -- the Visualiner CD-ROM software includes special programs designed to accommodate vehicle alignment procedures of particular automotive manufacturers. When applicable, these special routines can be enabled through the Software Configuration Menu:

Standard options only -- the alignment routines and features are the standard ones recommended by the majority of auto manufacturers.

Suspension Plus program -- this option enables a special routine for the newest Audi and Volkswagen vehicles (1996 Audi A4, A8 and 1998 VW Passat).

Renault options -- this option enables a special routine for Renault vehicles that includes ride height measurements to generate camber specifications.

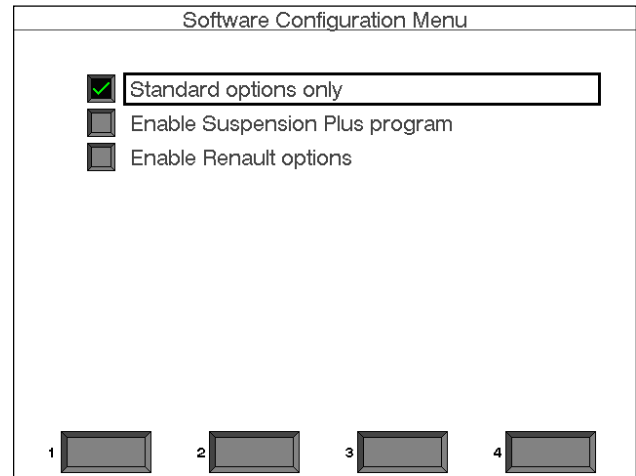

3. Customize Interaction

The Customize Interaction portion of the Setup Menu allows the operator to tailor the alignment software program based on personal preferences and the need to include specialized procedures.

The Customize Interaction Menu choices are:

Alignment order -- alters the order in which certain screens appear during alignments.

Skip allowed -- enables the operator to skip certain items, or disables the ability to skip these items.

Displays -- changes the look of some screens, includes volume and brightness controls.

Optional alignment features -- select certain alignment routines as in the path or on-demand.

Optional alignment styles -- further selection of routines and other special items.

Security code word -- used by John Bean Company to upgrade future software releases, update specifications, and enable certain software options.

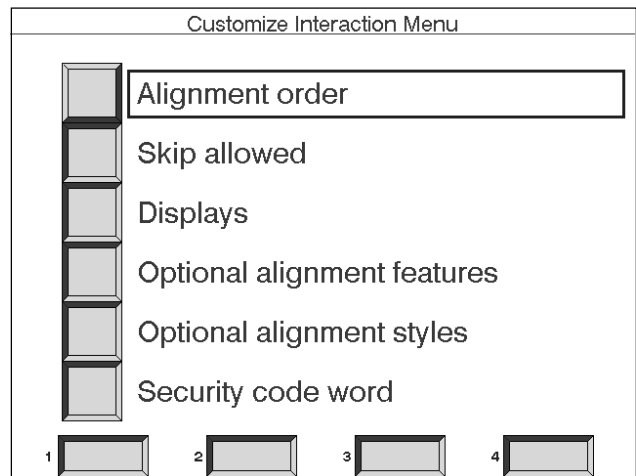

3a. Alignment Order -- Use the up/down arrow keys to select the Alignment function to be changed and press Enter. The instructions at the bottom of the Menu say to enter a number (1-6) to designate the order the items appear during alignments. Use the arrow keys to scroll the number up or down or type the desired number on the keyboard. Press Enter when satisfied with the selection. A soft-key has been provided to return the Visualiner back to its factory default settings. Press soft-key #1 on the remote or on the keyboard to perform this function. After all selections have been made, press Enter.

Note: Some items such as Runout, cannot be removed from the alignment program. Also, some items cannot be moved behind others.

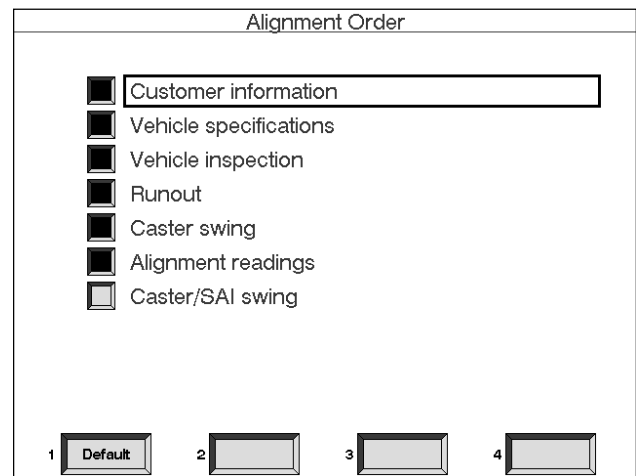

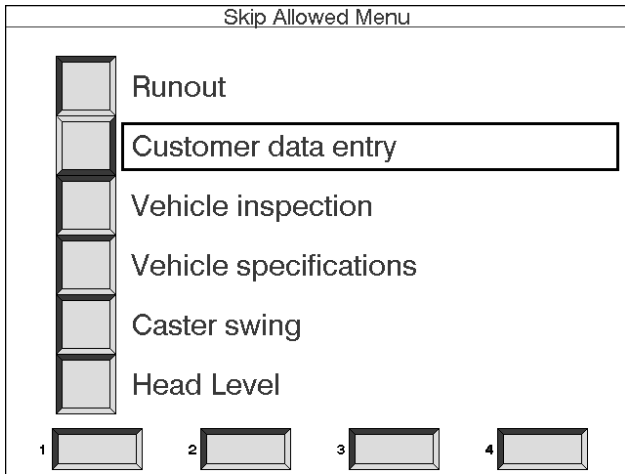

3b. Skip Allowed -- this menu allows certain functions to be skipped during the alignment program sequence by pressing the "NO" button on the remote, head keypad, or keyboard. If Skip "Not Allowed" is enabled for any item, the equipment operator will not be allowed to bypass that step -- it must be performed to allow progression of the alignment program.

Note: Skipping runout, caster sweep, and head level (Surround Sensor models only) is primarily for the convenience of John Bean Company personnel. Skipping any of these items during actual wheel alignments may result in incorrect angle measurements and customer comebacks.

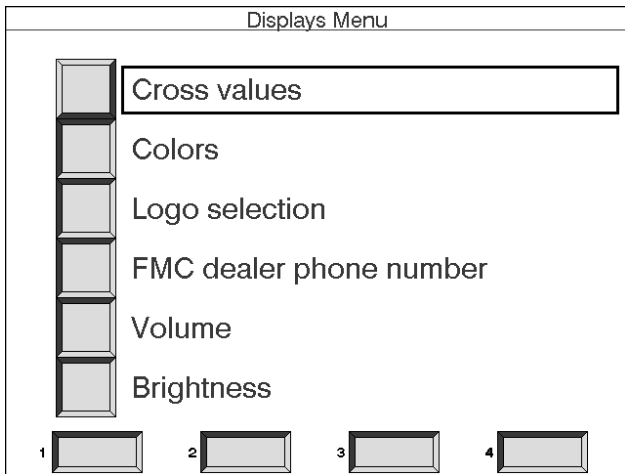

3c. Displays -- Choose Displays from the Customize Interaction Menu. The choices are:

Cross values -- select whether to have Cross values shown on the Front and Rear Readings screens

Colors -- choices are standard color or monochrome

Logo selection -- option which allows the choice of many custom logos for the Logo screen. This selection is password protected -- for John Bean Company personnel only.

John Bean Co. dealer phone number -- the number for the John Bean Company sales or service representative can be put in for display on the Logo screen

Volume/Brightness -- adjusts aligner sound volume and screen brightness using the soft-keys #2 and #3. Test the sound using soft-key #1.

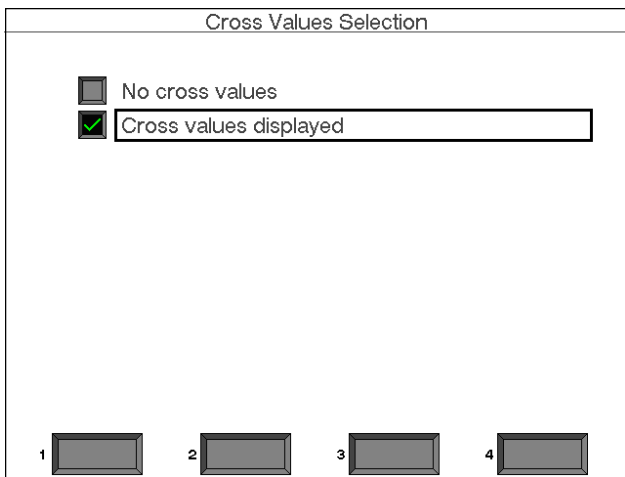

3c-i. Cross Values Selection -- cross values is the difference between the left and right readings for the caster and camber angles. These values are useful for diagnosing pull conditions, and on some vehicles a maximum cross value is specified. We highly recommend displaying the cross values on screen.

3c-ii. Colors Selection -- the choices for color displays are standard colors or monochrome (gray scale). The monitors offered on the Visualiner Series are VGA color so the best choice is standard.



3d. Optional Alignment Features -- from here, additional setup items include:

Shim manufacturer selection -- choose the brand of aftermarket rear shim utilized during the rear alignment process on many front wheel drive cars.

Advanced driver complaint -- activates a built-in help system based on vehicle drivability symptoms.

Setback/Vehicle dimensions -- choose whether to have this feature as a step in the alignment process or on-demand when needed.

Calibration check -- utilized for 8 Sensor Surround Sensor Edition models for setting pass/fail criteria.

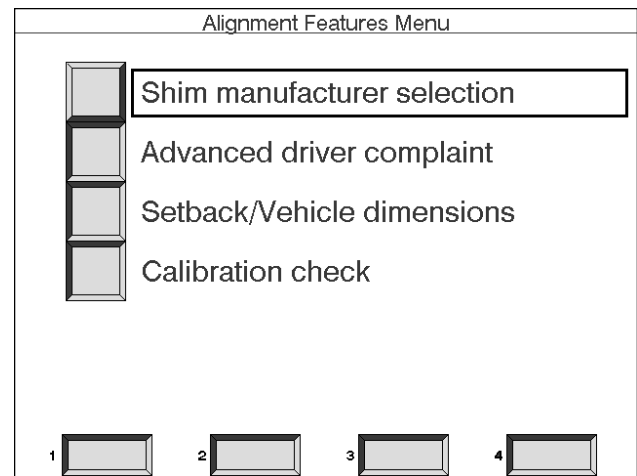

3d-i. Shim manufacturer selection -- used to select a rear wheel alignment shim manufacturer. This enables a special program to determine the correct shim to use when aligning the rear wheels on many front wheel drive vehicles. Any or all of the listed manufacturers can be used.

Note: Choosing more than one shim manufacturer will slow down the shim calculation time. It is advisable to select one primary and one secondary shim supplier.

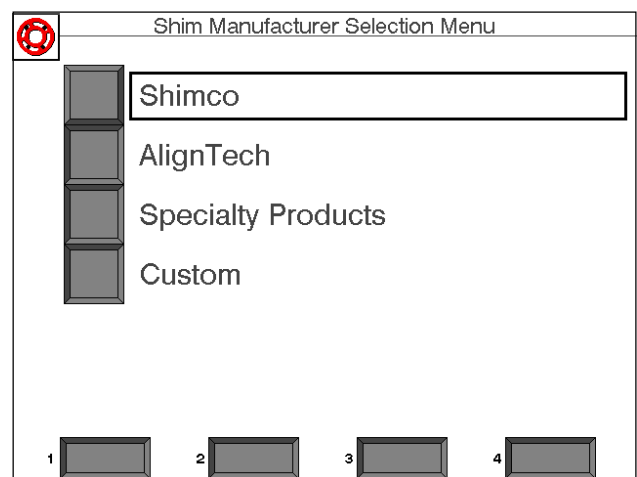

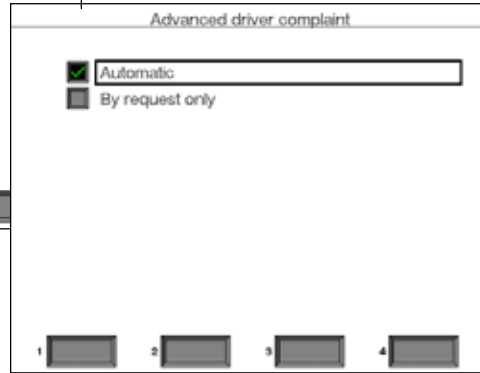
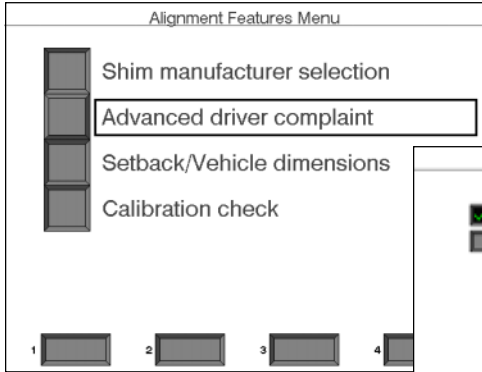

3d-ii. Advanced Driver Complaint -- when placed in the "Automatic" mode, the Visualiner software examines the caster, camber, SAI, and toe readings and specifications during the alignment routine and displays an analysis of typical driver symptoms or vehicle problems. This does add additional steps to the alignment process. This same analysis can be obtained for any vehicle as desired by the operator when the choice of "By request only" is selected. See page 60 for more details.

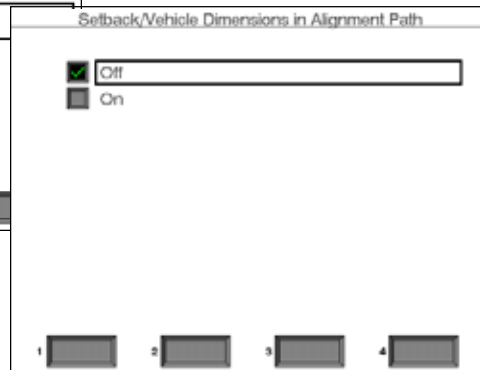
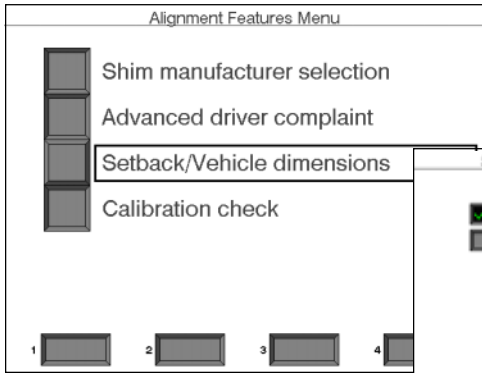

3d-iii. Setback/Vehicle Dimensions -- this setup determines whether the setback measurement is made automatically by the Visualiner software as a part of the standard alignment routine. On 8-sensor Surround Sensor models, vehicle dimensioning (i.e. wheelbase & trackwidth) is a part of the setback routine. Even if these measurements are not setup within the path they can be selected during the alignment of any vehicle.

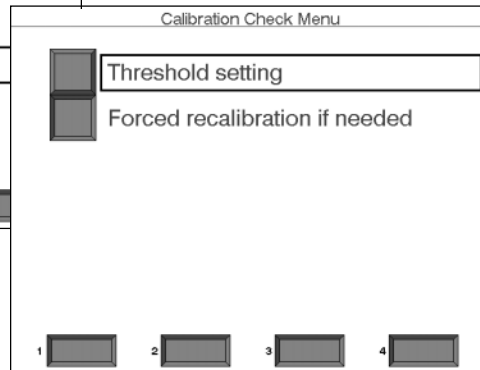
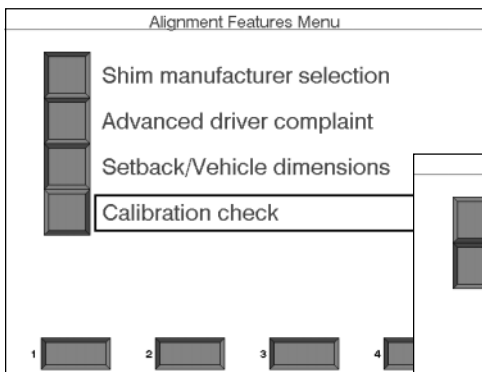

3d-iv. Calibration check -- this selection is only possible with 8-sensor Surround Sensor models. These units have the ability to perform automatic calibration checks with each alignment performed and alert the operator to an out-of-calibration condition. Under the Calibration Check Menu is the "Threshold setting" which selects the point where a warning message is displayed when the unit moves out of calibration. The "Force recalibration .." option requires a password to enable. For more details see the Surround Sensor Operation Supplement included with the 8-sensor heads.

3e. Optional Alignment Styles -- additional alignment programming setups under the Customize Interaction Menu. Choices are:

Caster/Camber @ 0 toe -- some auto manufacturers specify caster and camber be measured with each wheel straight ahead (zero toe).

Thrust line alignment only -- this option allows the aligner operator to only perform 4 wheel or thrust line alignments.

Specification selection method -- standard or European specifications.

Printout type -- standard or European styles.

All readings display position -- changes where in the program the "All Readings" screen will appear.

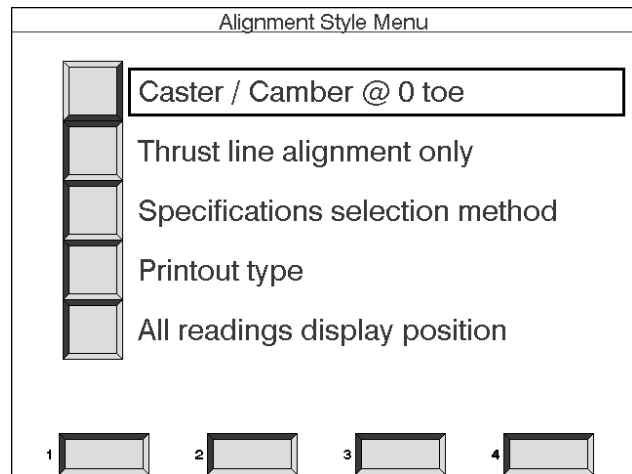

3e-i. Caster/Camber @ Zero Toe -- this option places additional steps in the alignment program that forces caster and camber to be measured on each side with the wheel pointed straight ahead. This procedure is recommended by several European auto manufacturers (i.e. Mercedes Benz) as the proper method of measuring these angles (see vehicle service manual). The recommended setting for this option for most vehicles is "Off".

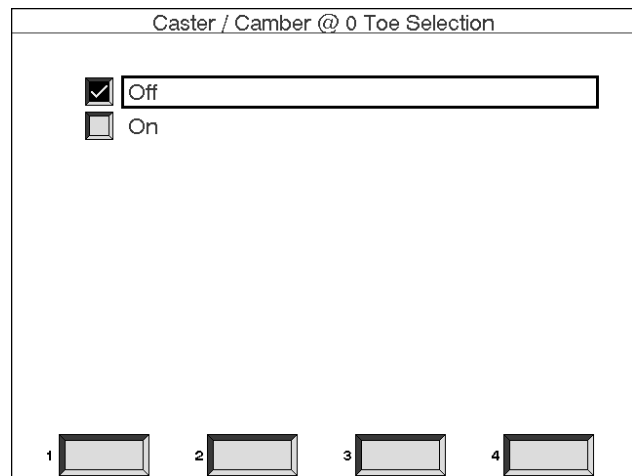

3e-ii. Thrust Line Alignment Only -- this item gives the operator the ability to dictate which types of wheel alignment selections are available during the alignment program. Selecting "Allow thrust or geometric alignments" allows the operator to perform 2 wheel, thrust, or 4 wheel alignments. Selecting "Allow only thrust alignments" allows only thrust or 4 wheel alignments -- 2 wheel alignments cannot be done.

The majority of vehicles today require complete 4 wheel alignments in order to restore proper handling and insure long tire life.

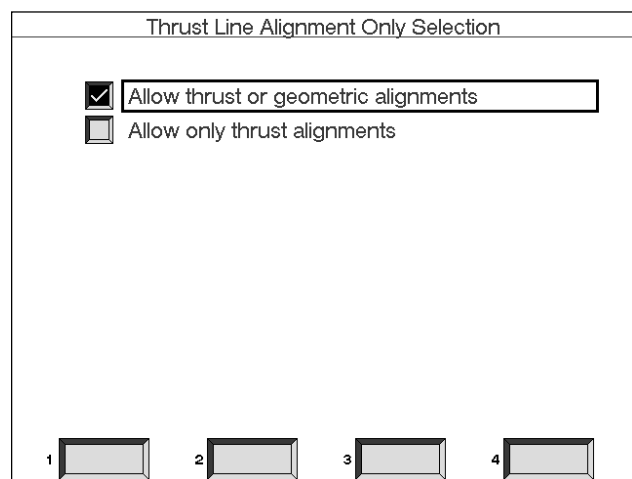

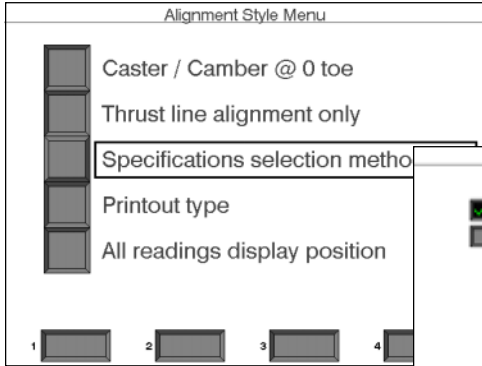

3e-iii. Specification selection method -- this option determines the format of the vehicle specification selection. The standard format, the default, uses the vehicle manufacturer as a starting point for spec selection.

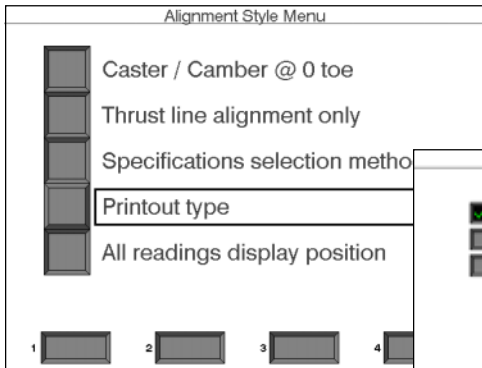
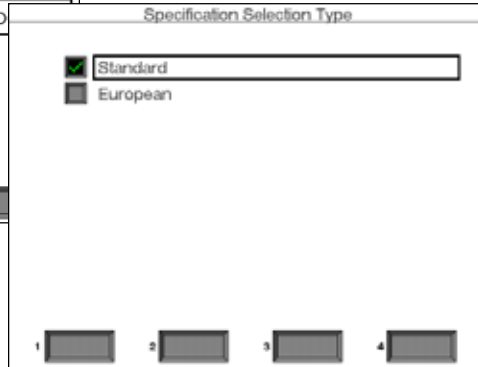

3e-iv. Printout type -- there are several different printout format styles that are available, depending on preference dictated by certain locations in the world. By default, the "Standard" printout type is enabled, with optional Northern or Southern European formats.

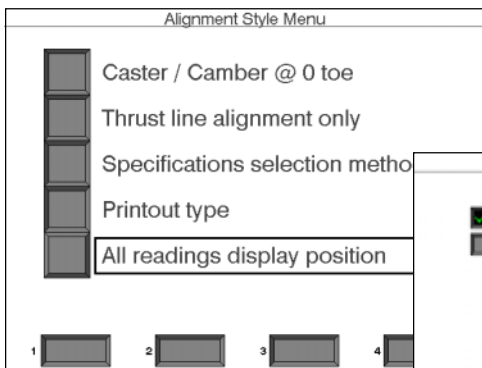
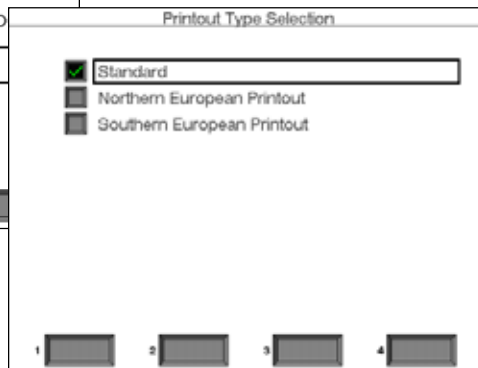

3e-v. All readings display position -- there are three different alignment readings screens during the software path -- Front, Rear, and All Readings (front & rear on the same screen). This selection allows the operator to establish when the All Readings screen will appear, either first before the front & rear meter screens or last after the meter screens.

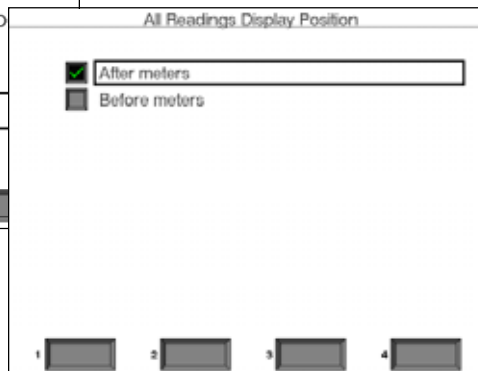

4. Language

A variety of different languages are available for the Visualiner Series CD-ROM software models. Place the highlight box around Language on the Setup Menu and press Enter.

The **Language and Spec Menu** gives the following sub-menu selections:

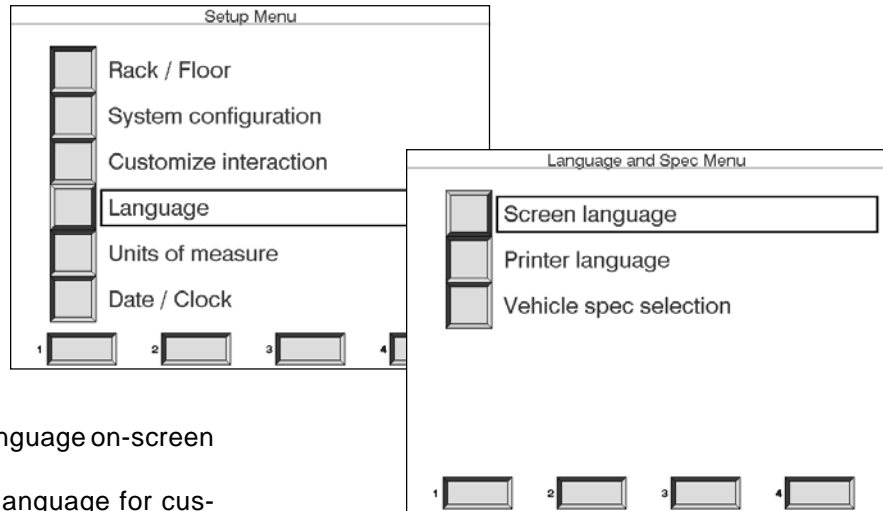

Screen language -- choose the language on-screen text will be displayed.

Printer language -- choose the language for customer printouts.

Vehicle spec selection -- choose the vehicle specification database for the country the aligner is used.

4a. Language Selection -- To change the language displayed on the screen or printout, select the item on the Language and Spec Menu. Press the up/down arrow keys until the desired language is encircled by the highlight bar and press Enter. Notice the "scroll bar" on the right side of the screen, indicating additional choices are available on a second page. Use the arrow keys or "Page Forward" key to move to page two. All screens will now be in the chosen language. English is the first selection on the list, should it become necessary to change the unit back to the default setting. For Asian aligners, Chinese will be the first language listed. On floppy software units, only two of the listed languages are available.

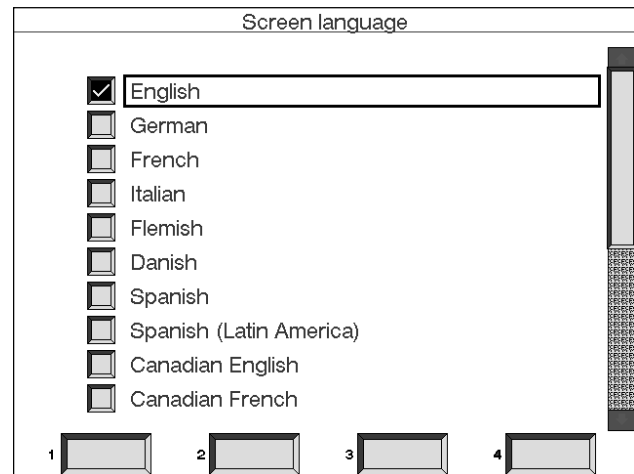

4b. Vehicle spec selection -- the Visualiner CD-ROM software contains wheel alignment specifications for the vehicles from many countries and markets. This setup option allows for changing the spec database to suit the country where the Visualiner is operated.

Note: some automotive markets not specifically identified on this screen have vehicles from a variety of sources. It may be necessary to change databases in order to locate specifications on some vehicles.

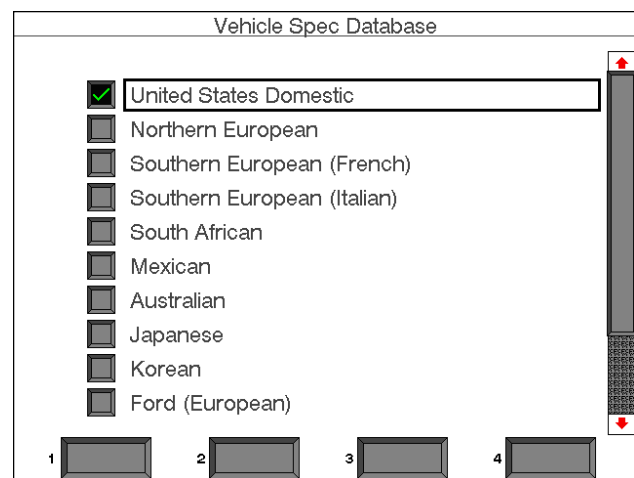

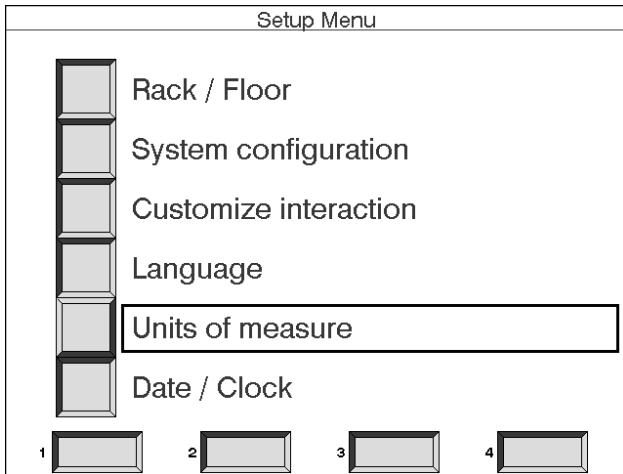

5. Units of Measure -- there are many different units of measurement for wheel alignment angles and dimensions depending on local practices, vehicle manufacturer requirements, or operator preference. Choose Units of Measure from the Setup Menu to select the units of measure as needed. Once a prescribed unit of measure has been chosen, all readings and specifications will be stated in those units.

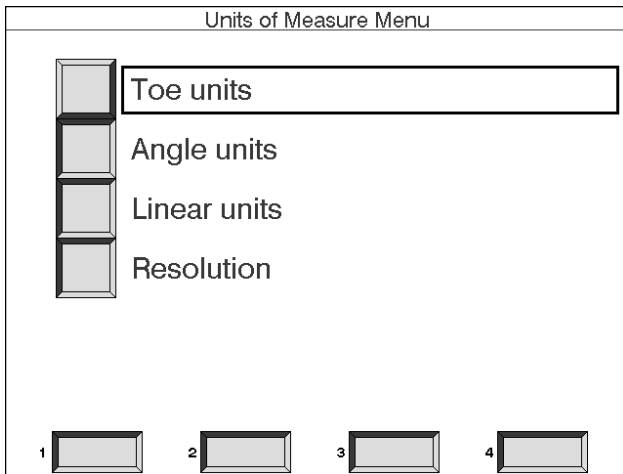

Units of Measure Menu -- the choices are:

Toe units -- specify the units in which all toe angle measurements will be displayed.

Angle units -- specify the units in which all angular measurements will be displayed (caster, camber, SAI, included angle, thrust angle, etc.).

Linear units -- specify the units in which all linear measurements will be displayed (setback, vehicle dimensions, etc.)

Resolution -- specify what resolution all on-screen digital displays will have

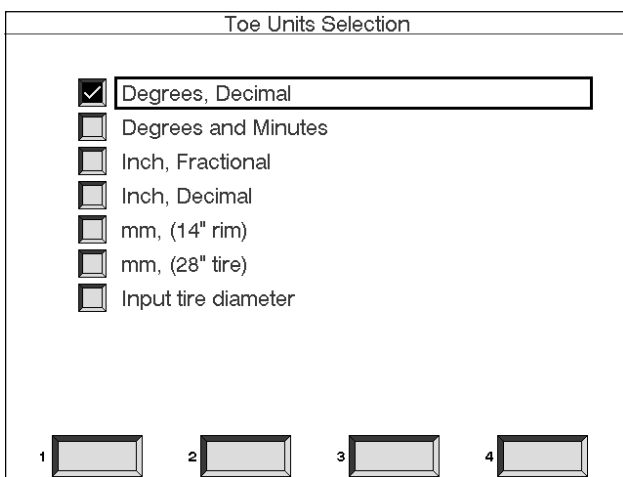

5a. Toe Units Selection -- move the highlight bar over the toe units best suited to the operator's requirements and press Enter. The choices are, with examples:

Degrees, Decimal -- 0.5 degrees

Degrees and Minutes -- 0' 30"

Inch Fractional -- 1/4"

Inch Decimal -- 0.25"

mm, (14" rim) -- European metric display -- 20 mm

mm, (28" tire) -- US metric display -- 20 mm

Input tire diameter -- prior to bringing up toe specifications during the alignment program, the Visualiner will ask for the actual vehicle tire diameter. The toe specs and readings will then be calculated based on that input value.

5b. Angle Units Selection -- move the highlight bar over the angle units best suited to the operator's requirements and press Enter. The choices are, with examples:

Degrees, Decimal -- 0.5 degrees

Degrees and Minutes -- 0' 30"

Degrees, Fractional -- 1/2 degree

All specifications, on screen readings, and printouts will be in the chosen units.

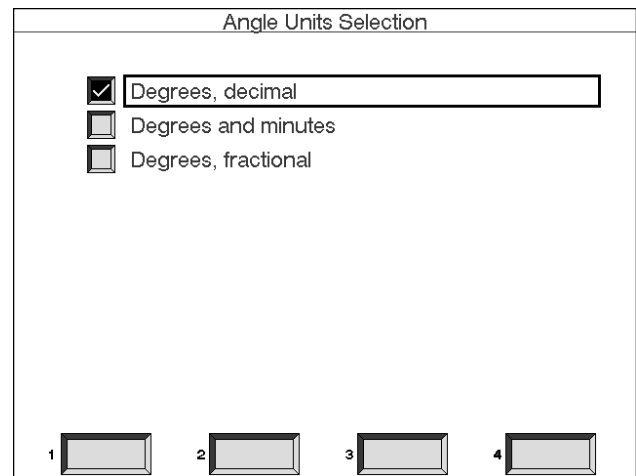

5c. Linear Units -- select the units for any linear-based measurements during the alignment program. Choices are English "Inches" or metric "MM" millimeters.

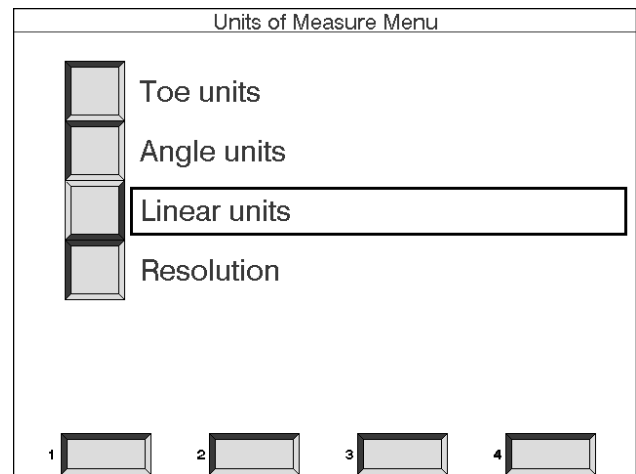

5d. Resolution Selection -- use the Resolution Menu to choose how digital displays are to be read during the alignment program. Choices are Normal (0.10 degree or hundredths of a degree) or High (0.01 degree or tenths of a degree) resolution. Regardless of choice it won't effect the accuracy of the Visualiner.

The selection will effect the way Alignment readings are viewed. Adjustments using a 0.1 degree resolution will be easier to obtain than when using the 0.01 degree setting. Aligning the car to within a hundreds of a degree requires a greater degree of precision to obtain exact readings.

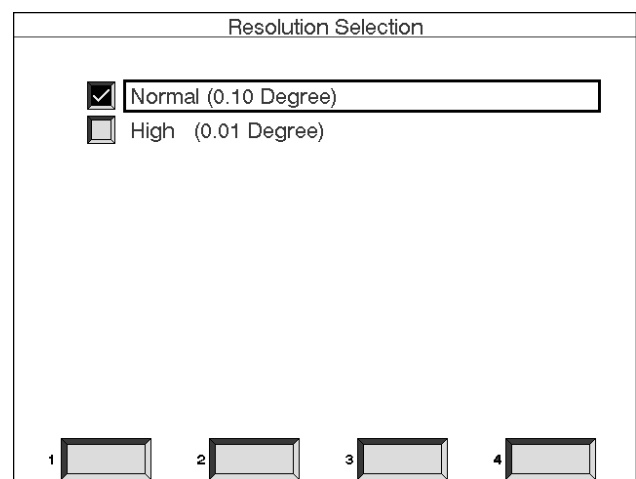

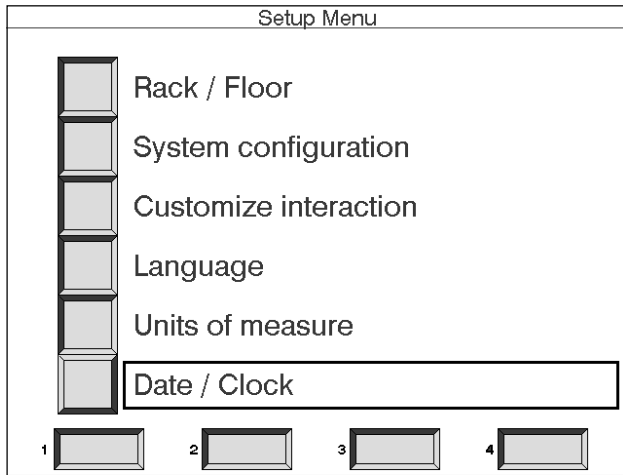

6. Date / Clock -- The last item on the Setup Menu sets the Date and Clock and the desired format for displaying them. The Visualiner Series contains an internal clock, but it may be necessary to reset the clock after time zone changes or if the computer has been reset for some reason. From the Setup Menu, place the highlight bar around the "Date / Clock" item and press Enter.

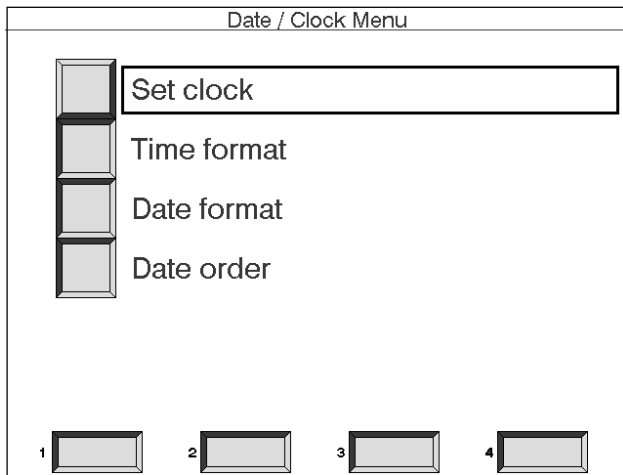

Date / Clock Menu -- the choices are:

Set clock -- set the month, day, year, hour, and minute. Adjust the clock using soft-keys #2 [-] to adjust the time backwards and #3 [+] to advance the time. Use the up/down arrow keys to highlight each item.

Time format -- choose 24 hour or AM/PM

Date format -- choose the desired style for the date

Date order -- choose the order in which the day, month, and year appear when the date is displayed.

This completes the customizing of the Visualiner Series Aligner. Going through the Setup is an excellent way to see how easy it is to navigate the Visualiner Series. Everything needed to operate the aligner is either on the menu or a further explanation can be accessed with the use of the Help Key. Now that the Visualiner is setup and ready to operate, proceed to the User Guide portion of this manual to learn how to complete a wheel alignment using the many powerful and easy-to-use software features.

HELP ?

Use the Help function should you require further assistance on Setup procedures. The Visualiner has a unique operator help system which is designed to provide instant access to information relative to the function being used. Use this any time you require further assistance by simply pressing the Help key.

(Blank Page)

(Blank Page)



Visualiner Series

Operation Instructions

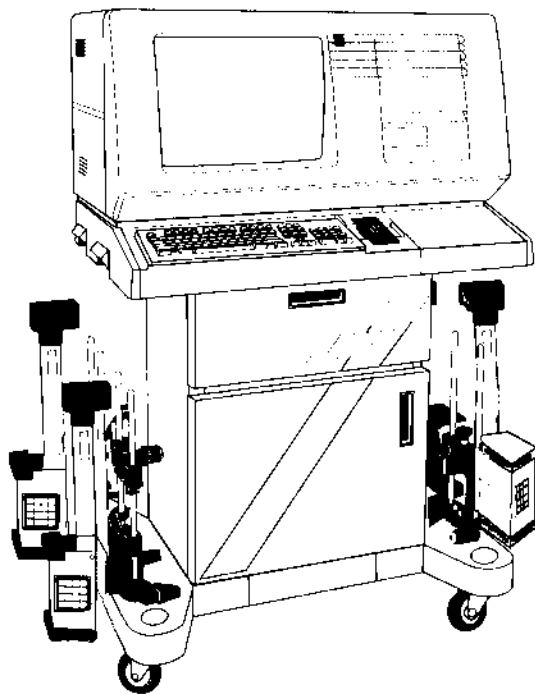

(Blank Page)

Introduction

The Visualiner Series Aligner assists the automotive technician through all aspects of the wheel alignment from gathering of customer information, performing vehicle inspections, measuring the important wheel alignment angles, and assisting with vehicle adjustments if necessary to correct any out of specification conditions.

The Visualiner Series software is "menu driven", meaning that each screen contains several options or selections to choose from. In most cases the instructions on screen will describe what actions to take next. Follow these instructions carefully to insure good results.

The following pages outline the steps to perform a complete wheel alignment. The first portion details the "programmed steps" to gather all necessary alignment readings. These steps are consistent with accepted wheel alignment practices in the industry. In some cases these steps can be eliminated or skipped in order to speed up the gathering of alignment readings (see Setup options in section 2).

The second portion describes the many features designed to assist the technician with diagnosing and correcting any vehicle alignment problems. If at any time there is a question during the alignment process, press the Help key to access the operator help screens.

Note: this manual covers all available software features of the Visualiner up to CD-ROM release Version 4.1. Earlier versions and lower levels of software may not contain all the features found in this manual. Consult John Bean Technical Support if there are questions regarding particular features.

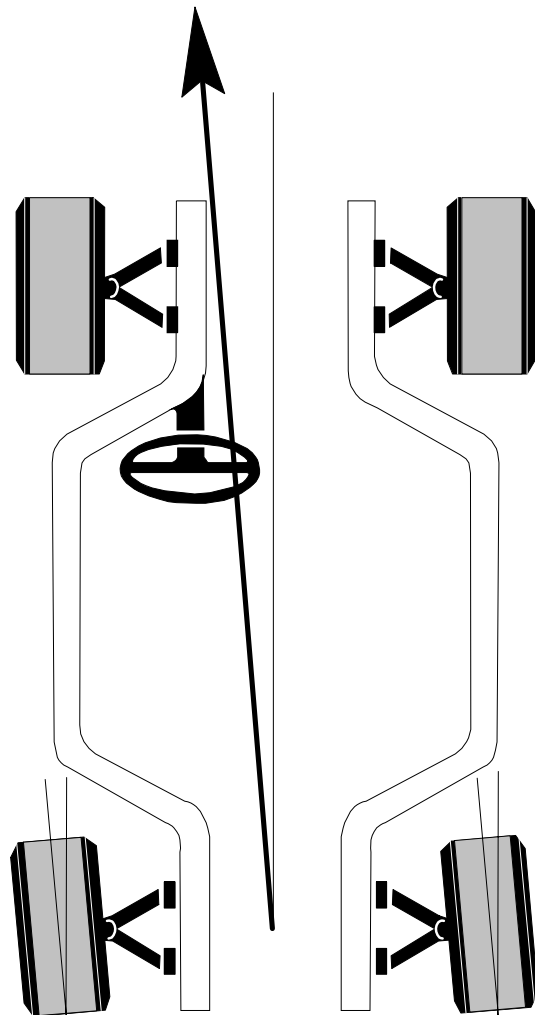
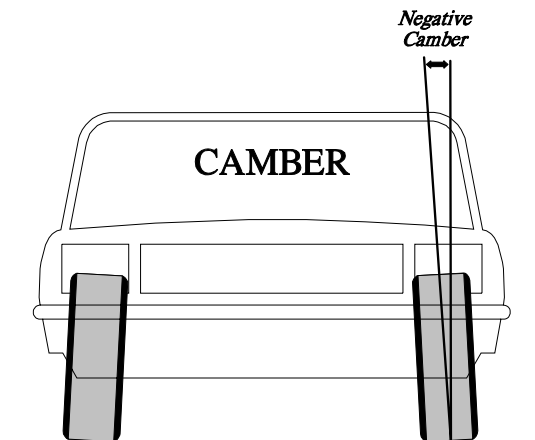

(Blank Page)

Steps To Performing A Quality 4 Wheel Alignment

There are many reasons why a wheel alignment may be performed on a vehicle such as:

- Accelerated or uneven tire wear
- Pulls, wandering, or other steering or handling problems
- Replacement of worn suspension or steering system components
- After collision repairs
- Routine vehicle maintenance

Regardless of the reasons for alignment, it is important that the technician perform the steps necessary to address and correct all problems.

1. Gather information from the vehicle owner -- ask about any drivability problems that may be symptoms of misalignment. Inquire if the vehicle has been in a collision or has had any recent parts replaced.
2. Perform a test drive to verify owner's complaint - try to recreate the problem. If unable to duplicate, have the vehicle owner explain further or have him/her drive with you.
3. Inspect the tires for any signs of abnormal wear - the tires usually reflect any misalignment conditions.
4. Perform a thorough inspection of suspension and steering system components -- many misalignment problems are created by worn or damaged components. Replace defective parts prior to performing the alignment. Always check tire pressure and ride height. Refer to manufacturer recommendations and tolerances when checking suspension and steering systems.
5. Make sure the wheel alignment equipment is accurate -- periodic maintenance of alignment equipment is essential -- regular instrumentation calibration, a level lift surface, free moving turntables and rear slip plates, etc.
6. Place vehicle on the alignment lift -- center the vehicle on the lift and turntables. Place the lift at a solid, level position.
7. Choose the proper alignment type for the vehicle -- the best alignment for the majority of vehicles is a 4 wheel alignment.
8. Perform runout compensation -- the purpose of performing runout is to eliminate any measurement errors due to the wheel and clamp mounting. Take the time necessary to perform runout correctly.
9. Measure caster, camber, and toe -- follow the procedures on the screen carefully. Refer to Operator's Manuals for further instructions.
10. Determine what needs to be done -- study the measured angles for the front and rear prior to performing corrections to match misalignment with any symptoms discovered earlier. If necessary, use the Visualiner's advanced functions to diagnose further problems (such as SAI / Included Angle, Toe out on Turns, Toe Curve Change, etc.). Examine the vehicle and any reference materials to determine the procedures for angle corrections. Determine what items are needed to correct any problems (i.e. aftermarket kits, special tools, etc.).
11. Make any needed angle corrections -- center the steering wheel carefully before adjusting toe. If the front total toe is beyond $1/2^\circ$ ($1/4"$) in or out, first adjust the front toe to zero. Then, use this order of adjustment:
 - a. Rear camber
 - b. Rear toe
 - c. Front caster
 - d. Front camber
 - e. Front toeUse the many adjustment assistant features built into the Visualiner to aid with proper angle correction. After performing any caster adjustments, re-measure using the 20° sweep to verify the results.
12. Re-center the steering wheel and readjust front toe if needed -- crooked steering wheels are the leading cause of customer dissatisfaction with wheel alignments. This simple step will minimize the number of comebacks.
13. Print the results -- the printout is useful for showing the customer before and after results. Many shops keep a printout on file for future reference.
14. Perform a test drive to verify proper alignment Have all the owner's drivability complaints been solved? Does the vehicle drive straight? Is the steering wheel straight? If necessary, bring the vehicle back on the alignment lift to correct any issues.

Wheel Clamps/Measuring Heads

Prior to beginning an alignment, attach each wheel clamp/head assembly to a vehicle wheel. The heads with the extended booms are placed on the front wheel with the booms pointing forward. Note there are several ways the wheel clamps can be attached to accommodate various wheel configurations.

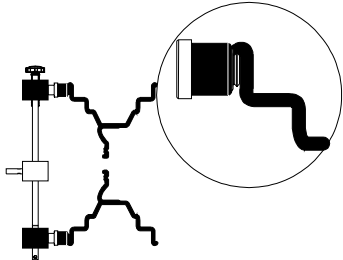

Option 1

This option is used on many standard stamped steel rims. Use the knife edge as shown. Apply pressure to secure the clamp from the inside out by turning the lock knob several turns clockwise.

This option is used on many custom rims with painted or polished surfaces that need extra care. Set the rubberized surface inside the wheel rim as shown. Apply pressure to secure the clamp from the inside out by turning the lock knob several turns clockwise.

Option 2

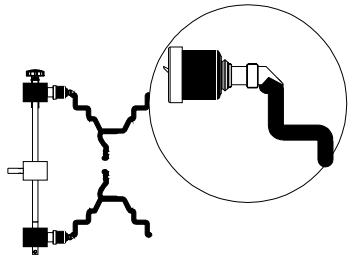
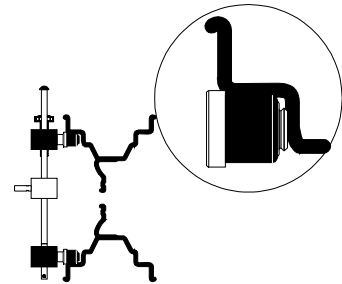

Option 3

This option is used on many standard and custom rims with no inside bead surface. Use the adapters supplied with the wheel clamp to insert between the wheel tire and the outside edge of the rim. Secure the clamp by turning the lock knob several turns counter clockwise.

This option is used on many standard and custom rims as above with low profile tires where a thin adapter is required between the wheels tire and rim. Use as option 3.

Option 4

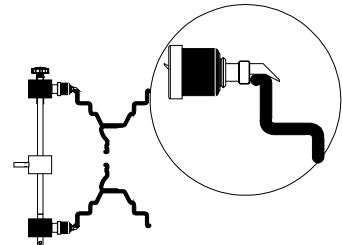

Option 5

This option is used on some standard and custom rims with no opportunity to clamp from the outside in and very narrow edges on the wheel rim. Clamp from the inside out. Use as option 1.

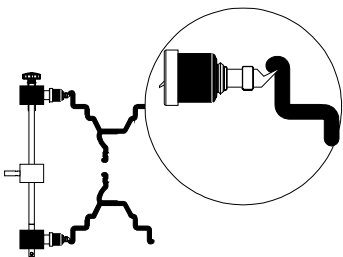

NOTE: Always secure the wheel clamps using the supplied safety straps onto each wheel to insure the head does not fall off the vehicle.

An optional Dual Wheel Offset Adapter is available for some pickups, motor homes and larger trucks to accommodate the difference in track width in the rear due to the dual wheel configuration. To use this adapter, remove the head assembly from the wheel clamp shaft. Place the Offset Adapter on the clamp shaft and tighten the locking knob. Place the head on the adapter shaft, tighten the knob, and mount the clamp using one of the methods above.

Performing a Wheel Alignment

Step 1. Main Menu -- Begin Alignment

Performing a wheel alignment begins at the Visualiner Main Menu screen. Place the highlight box around "Begin Alignment" and press Enter.

.....
TIP: The fastest way to see live readings on a vehicle is by pressing soft-key #3, "Readings", on the Main Menu screen. This will proceed directly to runout compensation and then directly to "All Readings" and display camber, toe, and thrust angle. There is no vehicle or customer information when Readings is used.

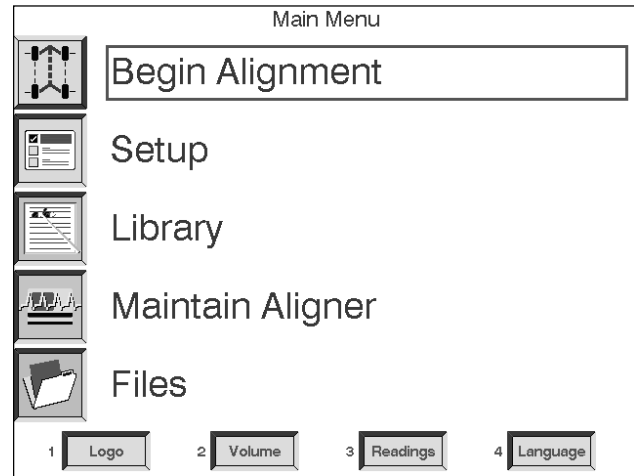

Step 2. Clear Aligner Menu

This menu gives the choice to start a new alignment or continue with an alignment already in progress. If "Begin new alignment (RESET)" is selected the computer memory of the previous alignment is erased allowing a new customer and vehicle to be setup.

If "Continue current alignment" is selected, all customer, vehicle, and alignment measurements are retained and the software returns to the alignment readings screens.

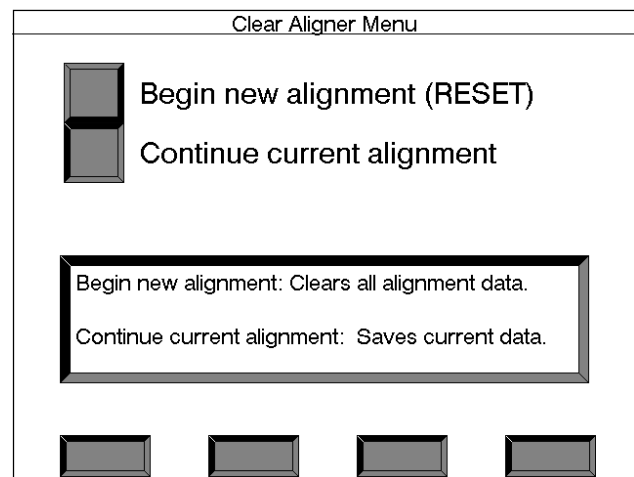

Step 3. Begin Alignment Menu

This menu is where the type of alignment is selected. The choices are:

Premium 4 wheel (thrust line) -- this type of alignment measures all angles on all 4 wheels and is preferred for most vehicles.

Front (steering may not be level) -- uses 4 heads but does not measure rear wheel or thrust angles, creating the possibility of a crooked steering wheel.

Quick readings -- goes to a sub-menu for selection of front, rear or all readings and eliminates all pre-alignment setup steps.

Driver complaints -- a symptom-based troubleshooting program as an aid to diagnosing drivability problems.

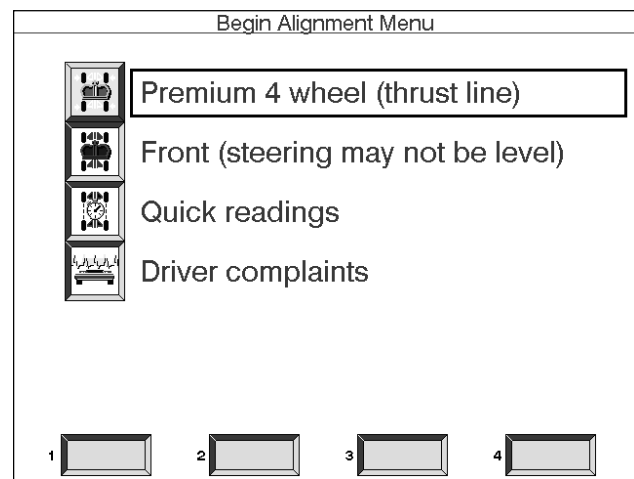

Performing a Wheel Alignment ... continued

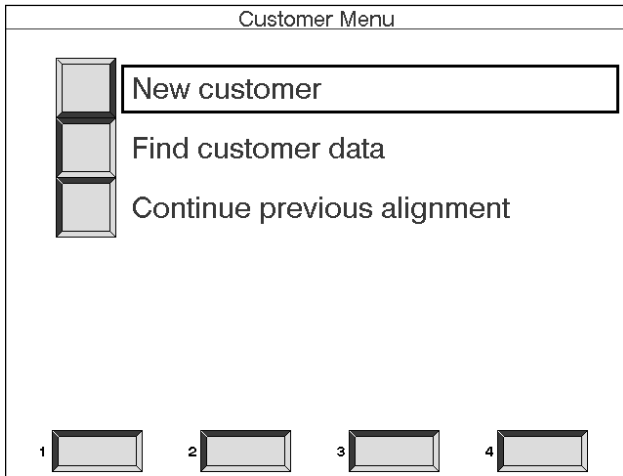

.....
TIP: Even if the customer is paying for a "Front Wheel Alignment" only, go ahead and measure the angles for all four wheels. It may reveal a problem in the rear that can be pointed out and sold, and provides the opportunity to get a straight steering wheel.

Step 4. Customer Menu

This menu gives the choice of setting up all new information for a new customer or utilizing a previously setup customer that is stored in the aligner's database (optional feature on some models). To use the customer database software, refer to section 5 "Files -- Customer Database" of this manual. Also, the option to continue the previous alignment is given here.

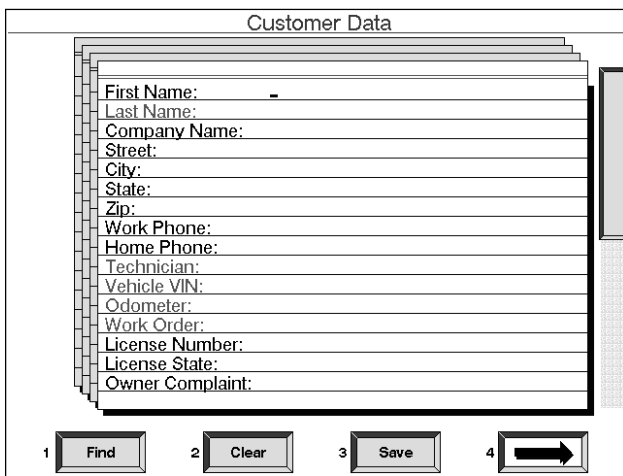

Step 5. Customer Data

If the Visualiner is equipped with the printer package (optional on some models) or the Customer Database option, this screen will appear next. It allows entry of all pertinent data about the customer and his vehicle. With the database software all this information can be saved for later recall. For the customer printout, only the fields in red are printed, so it is not necessary to enter the other information unless the information is to be saved in the Customer Database. Soft-keys #1 and #3 are used with the database feature, while #2 allows any typed information on-screen to be cleared. Once completed with this screen, press soft-key #4 to continue.

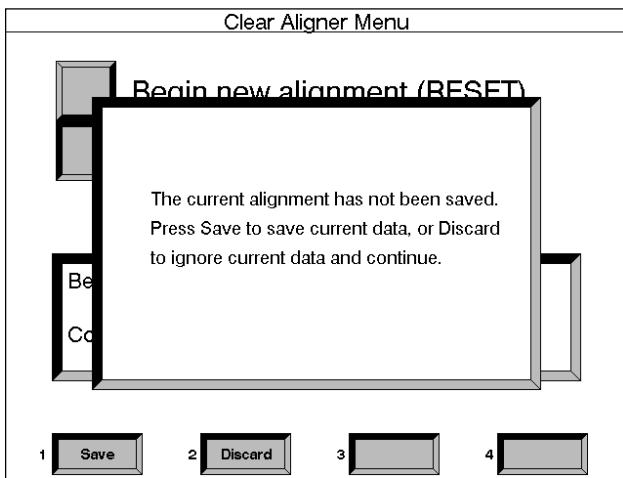

Not Saved:

When using a Visualiner with the customer database option, this message will appear when a new alignment is selected and the current work has not been saved. The selections are to "Save" or to "Discard". Saving will secure the information into the disk database. Pressing discard will erase all previous alignment information in the system.

Performing a Wheel Alignment ... continued

Step 6. Vehicle Manufacturer

This screen shows the vehicle manufacturers in the Visualiner specification database. Move the selection bar up, down or sideways with the arrow direction keys to select the manufacturer and press the "Enter" key. The vertical bar on the right indicates there are additional choices on a second screen. Use the "Page Down" key on the keyboard or use the down arrow key on any keypad to scroll past the last entry on this screen. Selecting soft-key #1 accesses "custom" specifications setup by the technician for vehicles not in the database. Selecting soft-key #2 allows access to "floppy stored custom" specs (optional). Soft-key #4 continues past this screen without any entry.

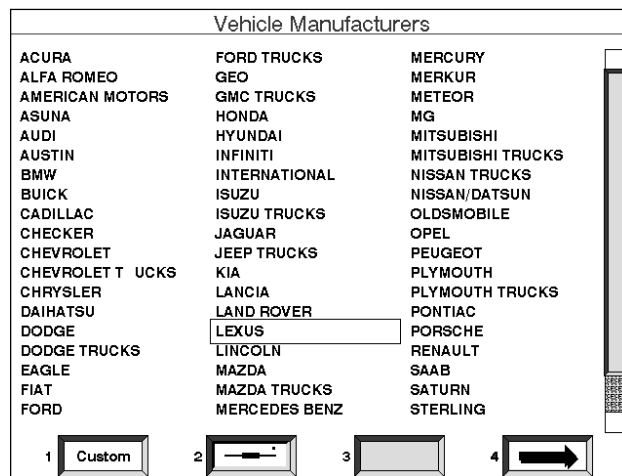

.....
TIP: To move to the manufacturer selection quicker, using the keyboard, press the first letter of the company name. This causes the selection bar to move directly to the first name starting with that letter (i.e. press "H" - moves to Honda).

Step 7. Vehicle Year

Select the year of manufacture using soft-keys #2 and #3 to move up or down to the desired year, then press the Enter key. Pressing the Up or Down arrow key on the keyboard also moves the year choice.

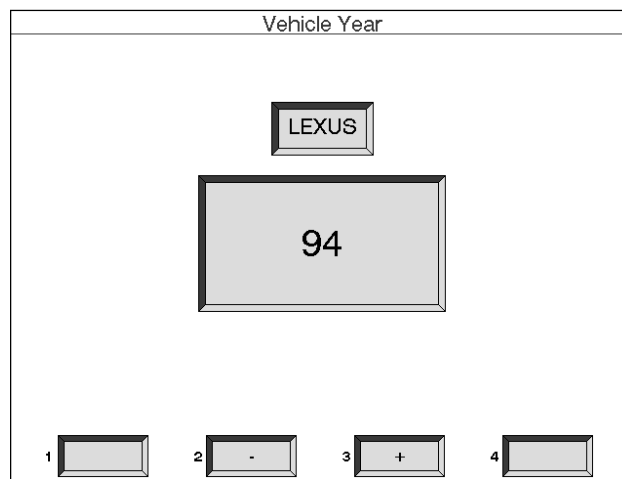

Step 8. Vehicle Model

Move the selection bar up or down with the direction keys to select the model of the vehicle, then press Enter.

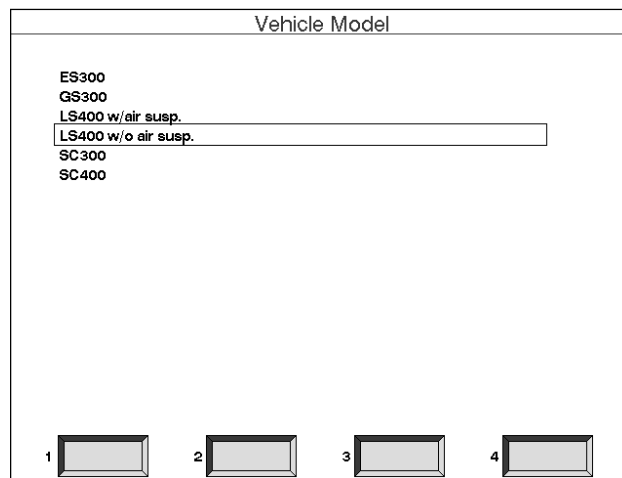

Custom Specifications -- alignment specifications that have been added by the operator will reside in a special database. To retrieve these specifications go to the Vehicle Manufacturers selection screen and press soft-key #1 "Custom". A new set of custom specifications can be added to the custom database from this screen and also by editing standard manufacturers specifications.

Performing a Wheel Alignment ... continued

Vehicle Specifications			
94 LEXUS LS400 w/o air susp.			
Front	MIN	PREF	MAX
Caster left	8.6°	9.3°	10.1°
Caster right	8.6°	9.3°	10.1°
Camber left	-0.7°	0.1°	0.8°
Camber right	-0.7°	0.1°	0.8°
Total toe	0.09°	0.25°	0.41°
SAI		8.8°	
Rear			
Camber left	-0.9°	-0.2°	0.6°
Camber right	-0.9°	-0.2°	0.6°
Total toe	-0.00°	0.16°	0.32°

1 2 3 4

Step 9. Vehicle Specifications

This screen displays the Year, Manufacturer, and Model of the selected vehicle with Minimum, Preferred and Maximum specifications for the front and rear wheels. Dashes in any position indicate there are no manufacturer specifications for that wheel or angle. For angles not displayed on this screen, refer to the specification book included in the literature package of the Visualiner. Soft-key #2 allows the technician to view an illustration of the vehicle's alignment angle correction method, while #3 allows editing of the specifications prior to beginning the measurements.

Front Camber Illustration

Lower strut mount cam (Camber adjustment)

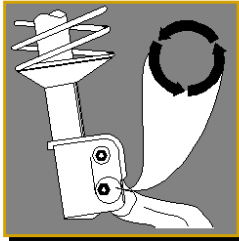

To adjust camber, loosen strut to knuckle retaining bolts and rotate cam bolt. Some vehicles have slots, but do not have a cam bolt. A special tool may be necessary to adjust the strut.

Parts required - SOME VEHICLES MAY REQUIRE CAM BOLT KIT.
Modifications required - NONE.
Special tool required - ON SOME VEHICLES WITHOUT CAM BOLTS.

CHECK LOCAL LAWS BEFORE INSTALLING ANY AFTERMARKET KITS.
--55--

Illustrate Adjustment -- illustrations of adjustment possibilities can be viewed by pressing soft-key #2 "Illust". If more than one picture is available (separate camber, caster and toe adjustments) the Enter key is used to move forward through the illustrations. To move back press the "Page Back" key, and to leave the illustrations at any time use the "NO" key found on any keypad. With CD-ROM software, soft-key #2, "Animate", will bring up a computer animated sequence that shows movement of the parts and suspension to better illustrate the alignment adjustment.

Vehicle Specifications			
94 LEXUS LS400 w/o air susp. User Customized			
Front	MIN	PREF	MAX
Caster left	8.6°	9.5°	10.1°
Caster right	8.6°	9.5°	10.1°
Camber left	-0.7°	0.1°	0.8°
Camber right	-0.7°	0.1°	0.8°
Total toe	0.09°	0.25°	0.41°
SAI		8.8°	
Rear			
Camber left	-0.9°	-0.2°	0.6°
Camber right	-0.9°	-0.2°	0.6°
Total toe	-0.00°	0.16°	0.32°

1 2 3 4

Edit -- it is possible to modify or edit specifications by pressing the "Edit" soft-key. A selection box will appear on the first specification value. Using the appropriate + or - soft-keys, change the value until the desired specification is displayed. Move to any additional values to be modified. After editing is complete, these specs can be saved as Custom specifications or utilized for only the current alignment. The vehicle specifications can be restored to original by pressing the soft-key "Restore" if they are edited by mistake. The "Continue" soft-key will advance to the programmed next step.

.....

TIP: Creating Custom Specifications -- OEM alignment specifications can change or may not be optimal for certain vehicles based on your experience. Creating a custom entry for popular vehicles will save time when customers come back for alignment.

.....

Performing a Wheel Alignment ... continued

Step 10. Inspection Menus

The Inspection Menu contains six choices of vehicle inspection lists. These lists allow the alignment technician to perform and print the necessary pre-alignment checks. Select the appropriate list using the directional control keys to move the selection box. Press "Enter" and the list will appear. If none of the inspections are to be performed use soft-key #4 "Continue" to advance in the program.

These inspection reports are a valuable tool for alignment specific or non-related reporting of vehicle problem areas. These reports can be retained for shop files or given to the customer as a service sales tool to reinforce his comprehension of the work performed, or the work necessary before an alignment can be performed. In many cases worn or damaged components will affect the quality of the wheel alignment.

Pre-alignment Inspection -- as an example, to enter information about the vehicle's suspension system, use the appropriate soft-key to indicate "Check", "Service" or "Replace" for each item on the list. Soft-key #4 "Blank" is used to "skip" an item if it doesn't exist on the vehicle. The vertical bar on the right indicates there are additional items on a second page. A printout of the inspection results can be obtained by pressing the "Print" soft-key. Only the inspection lists selected and completed are included in the final inspection list printout.

Tire inspection -- the tire inspection contains a series of checks for wear or damage. Tire problems are usually a good indicator of alignment and maintenance problems. Look for excessive wear or unusual wear patterns. Complete the list for each individual tire, then use the appropriate soft-key to move on to the next tire. Advance the program at any time using the #4 "Continue" soft-key. Tire pressure and size can be entered for each tire, by the console keyboard (optional).

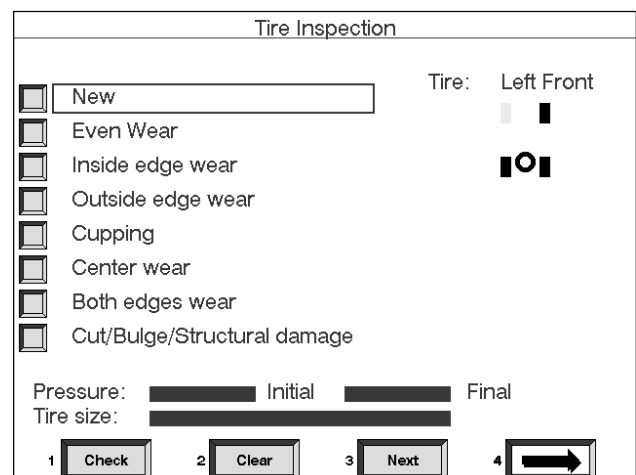
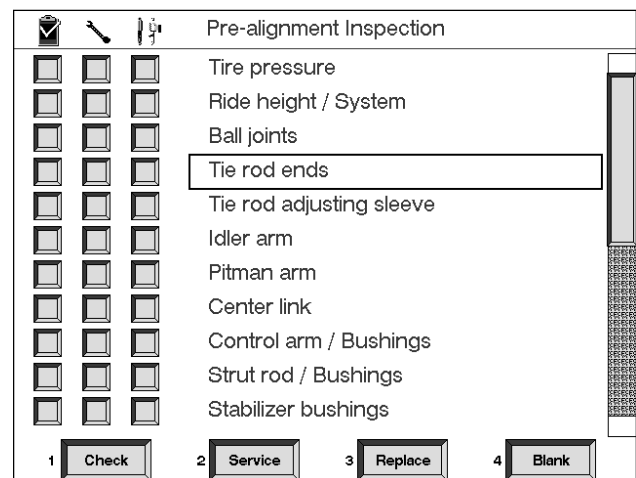
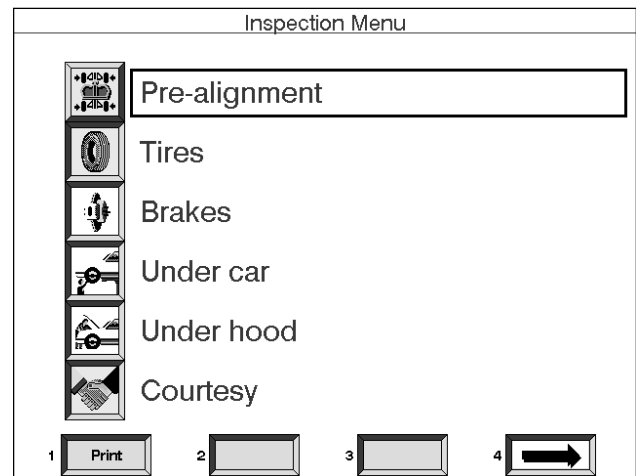

Performing a Wheel Alignment ... continued

Brake Inspection		
<input type="checkbox"/>	<input type="checkbox"/>	Fluid level
<input type="checkbox"/>	<input type="checkbox"/>	Fluid condition
<input type="checkbox"/>	<input type="checkbox"/>	Brake feel
<input type="checkbox"/>	<input type="checkbox"/>	Master cylinder test
<input type="checkbox"/>	<input type="checkbox"/>	Power booster
<input type="checkbox"/>	<input type="checkbox"/>	Combination valve
<input type="checkbox"/>	<input type="checkbox"/>	Parking brake
<input type="checkbox"/>	<input type="checkbox"/>	Parking brake cable
<input type="checkbox"/>	<input type="checkbox"/>	Calipers
<input type="checkbox"/>	<input type="checkbox"/>	Rotors
<input type="checkbox"/>	<input type="checkbox"/>	Brake pads

1 2 3 4

Brake Inspection -- the Brake Inspection list contains a series of items to check for wear or damage. Use the appropriate soft-key to indicate "Check", "Service" or "Replace" for each item on the list. Soft-key #4 "Blank" is used to "skip" an item if it doesn't exist on the vehicle. The vertical bar on the right indicates there are additional items on a second page.

Under Car Inspection		
<input type="checkbox"/>	<input type="checkbox"/>	Fluid leaks
<input type="checkbox"/>	<input type="checkbox"/>	Exhaust manifold
<input type="checkbox"/>	<input type="checkbox"/>	Exhaust fasteners
<input type="checkbox"/>	<input type="checkbox"/>	Exhaust gaskets
<input type="checkbox"/>	<input type="checkbox"/>	Exhaust pipes
<input type="checkbox"/>	<input type="checkbox"/>	Heat shields
<input type="checkbox"/>	<input type="checkbox"/>	Catalytic converter
<input type="checkbox"/>	<input type="checkbox"/>	Muffler
<input type="checkbox"/>	<input type="checkbox"/>	Tail pipe
<input type="checkbox"/>	<input type="checkbox"/>	Hangers
<input type="checkbox"/>	<input type="checkbox"/>	Clamps / Welds

1 2 3 4

Under Car Inspection -- an under car inspection can offer many opportunities for the technician to further his services to the customer. Mufflers, catalytic convertors, U-joints, and transmission mounts are a few of many items under the vehicle that can be inspected and reported to the customer.

Under Hood Inspection		
<input type="checkbox"/>	<input type="checkbox"/>	Coolant level
<input type="checkbox"/>	<input type="checkbox"/>	Coolant protection
<input type="checkbox"/>	<input type="checkbox"/>	Coolant recovery system
<input type="checkbox"/>	<input type="checkbox"/>	Coolant hoses
<input type="checkbox"/>	<input type="checkbox"/>	Belts
<input type="checkbox"/>	<input type="checkbox"/>	Oil level
<input type="checkbox"/>	<input type="checkbox"/>	Power steering level
<input type="checkbox"/>	<input type="checkbox"/>	Power steering hoses
<input type="checkbox"/>	<input type="checkbox"/>	Brake fluid level
<input type="checkbox"/>	<input type="checkbox"/>	Brake fluid condition
<input type="checkbox"/>	<input type="checkbox"/>	Windshield washer fluid

Under Hood Inspection -- an additional area to be considered is under the hood. A thorough vehicle inspection is a service to the customer to insure reliable and safe operation, while giving the opportunity to generate additional revenues to the repair shop.

Performing a Wheel Alignment ... continued

Courtesy Inspection -- this inspection menu allows non-alignment and safety related items to be inspected as a courtesy to the vehicle's owner. Some of the items included are fuses, seat belts, jacks, mirrors, etc.

Courtesy Inspection			
<input type="checkbox"/>	<input type="checkbox"/>	<input type="checkbox"/>	First aid kit
<input type="checkbox"/>	<input type="checkbox"/>	<input type="checkbox"/>	Fire extinguisher
<input type="checkbox"/>	<input type="checkbox"/>	<input type="checkbox"/>	Flares / Reflectors
<input type="checkbox"/>	<input type="checkbox"/>	<input type="checkbox"/>	Flashlight
<input type="checkbox"/>	<input type="checkbox"/>	<input type="checkbox"/>	Spare fuses
<input type="checkbox"/>	<input type="checkbox"/>	<input type="checkbox"/>	Jumper cables
<input type="checkbox"/>	<input type="checkbox"/>	<input type="checkbox"/>	Tow rope
<input type="checkbox"/>	<input type="checkbox"/>	<input type="checkbox"/>	Spare / Jack
<input type="checkbox"/>	<input type="checkbox"/>	<input type="checkbox"/>	Seat belt condition
<input type="checkbox"/>	<input type="checkbox"/>	<input type="checkbox"/>	Seat belt operation
<input type="checkbox"/>	<input type="checkbox"/>	<input type="checkbox"/>	Mirrors

1 2 3 4

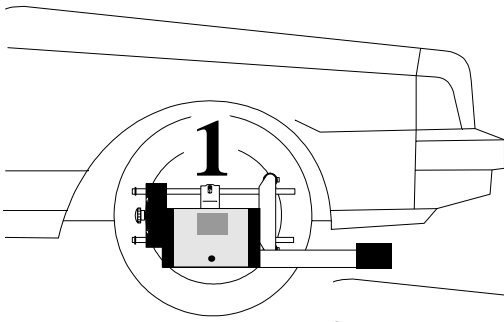

Step 11. Runout Compensation

Compensating for the amount of runout of vehicle wheel assemblies is an important factor in the alignment process. If not correctly determined, there will be errors in the displayed camber and toe angles. John Bean utilizes a runout procedure that calculates a true plane on the wheel assembly by measuring variations in toe and camber planes during a 360 deg. rotation of the wheel.

Attach each wheel clamp/head assembly to a vehicle wheel; the heads with the extended booms are placed on the front wheel with the booms pointing forward.

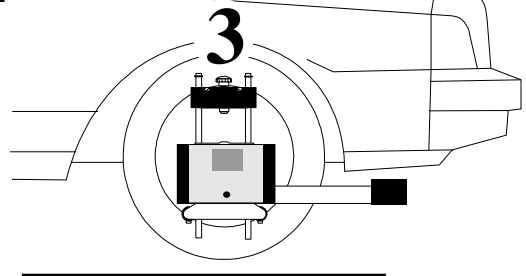
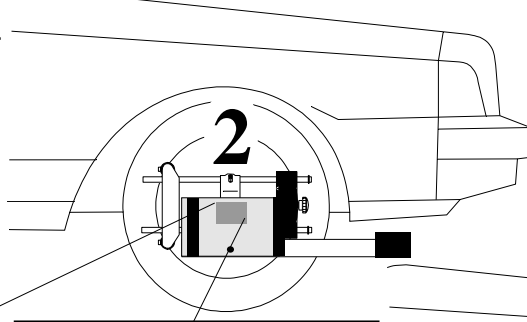

**Runout
key** →

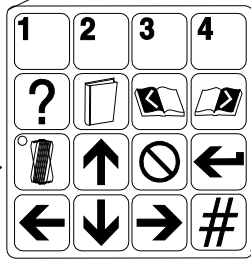

Runout Procedure

To perform wheel runout, raise the vehicle wheels off the alignment rack surface using air jacks or other method to allow the wheels to rotate freely. Follow steps 1 through 3 carefully.

After the first time the runout button is pressed a light will appear on the "Runout" key on the head, indicating the aligner is in the runout mode. As the runout key is pressed at position 2, the light will blink. At position 3 the light will blink and then go off, indicating the runout process is complete for that wheel. If the runout indicator light does not go out after step 3, something has gone wrong. Press the runout key until the light goes out, then repeat the complete 1-2-3 runout steps for that wheel.

The computer screen on the aligner will indicate the status of the wheel runout. Repeat these steps for all wheels.

1. As indicated on the drawing above , turn the wheel until the stamped-in number "1" is showing on the wheel-clamp center slide. Hold the wheel assembly here and press the "Runout" key on the head keypad.

2. Turn the wheel until the stamped-in number "2" is showing on the wheel-clamp center slide (180 deg). Hold the wheel assembly here and press the "Runout" key on the head keypad.

3. Turn the wheel until the stamped-in number "3" is showing on the wheel-clamp center slide (90 deg). Hold the wheel assembly here and press the "Runout" key on the head keypad.

Performing a Wheel Alignment ... continued

The Runout Compensation screen shows each wheel of the vehicle. As runout is successfully completed each wheel turns to a green color. If a moderate amount of wheel runout is detected, but not enough to influence the alignment results, a "Marginal Runout" message will appear and the wheel will turn yellow. It is acceptable to continue at this point. If a high amount of runout is detected, an "Excessive Runout" message will appear on-screen and the wheel will turn red. This problem must be corrected prior to proceeding. Excessive runout can be caused by incorrect wheel clamp mounting, a bent clamp, a bent or loose wheel, or a problem inside the measuring head. Once runout is completed on all wheels, lower the vehicle and press "Enter". On the CD-ROM software version, soft-key #2 will provide visual instructions for the runout procedure.

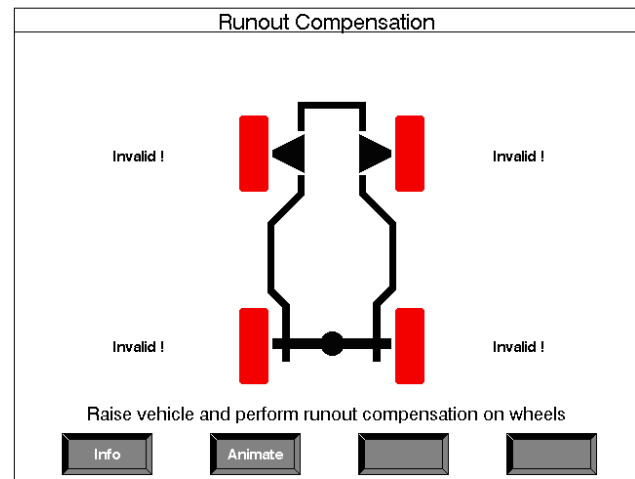

Here are some important notes regarding runout compensation on the Visualiner Series:

- > If "two heads" has been selected in the aligner Setup, only two wheels will be shown.
- > Runout can be completed or updated at any time and from any screen in the aligner. It is not necessary to start over if runout needs to be taken again. Any time a wheel is removed from the vehicle, or the clamp is removed from the wheel, runout compensation must be repeated on that wheel only.
- > The wheel clamp must remain in the straight up position (#3) at the end of the runout procedure. Do not rotate the clamp away from straight up for any reason. Be careful of many rear wheel and 4 wheel drive axles where turning one raised wheel causes another to move.
- > It is not possible to "fake" runout compensation. An "Invalid!" display on the screen means a wheel has not been properly compensated.
- > Do not skip or shortcut the runout compensation process in any way. It is an important part of obtaining accurate alignment angles.

After runout compensation is completed the aligner is ready to measure the vehicle's wheel alignment angles, beginning with caster.

Performing a Wheel Alignment ... continued

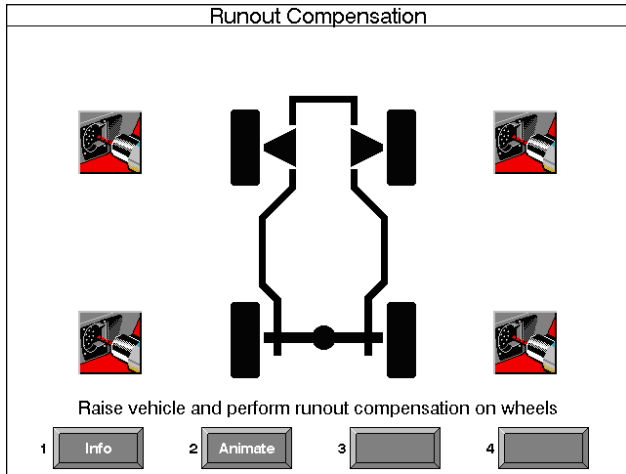

The "**Loss of Communication**" icon will appear on-screen when a head interconnect cable is disconnected or a head loses communication with the main computer. This situation can occur at any time during the alignment program and must be corrected prior to proceeding. Runout values are retained and accurate readings are restored as soon as valid communications is established.

Step 12. Measure Caster

The caster angle is measured by sweeping through a 20 degree turn of the front wheels. The software guides the operator through the steps on-screen. The caster sweep screens show a graphic of the wheels with the direction they should point, an arrow to indicate the turn direction, and a "stop light" that changes from green to red, with yellow in the middle, as the turning angle is reached. Always follow the arrow direction and hold the wheel steady until the wheel turns green and the screen advances.

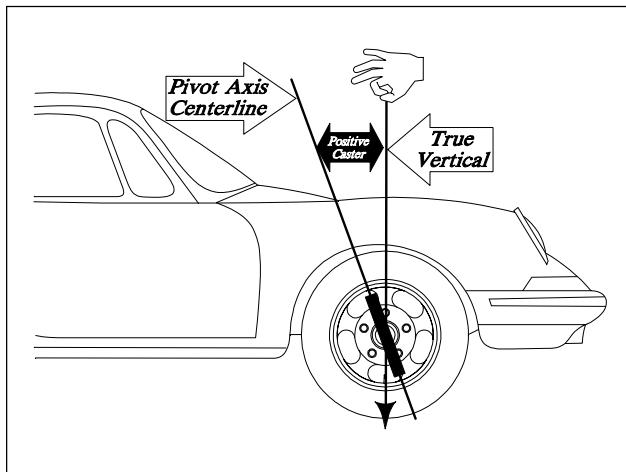

Steer Straight Ahead -- if the front wheels are not facing straight ahead, the first step of the caster sweep directs them properly.

Automatic or Manual Caster sweep -- the Automatic or the Manual caster sweep mode can be selected anytime during the caster swing procedure by pressing the soft-key #1. The mode presently selected will be indicated in the top center of the display. The Automatic mode utilizes the optical sensors to obtain the 10 degree turning angles and automatically progresses in the program when this angle is obtained. The Manual mode utilizes the turntable scales to indicate the appropriate 10 degree turn and the "Enter" button has to be pressed to progress in the program.

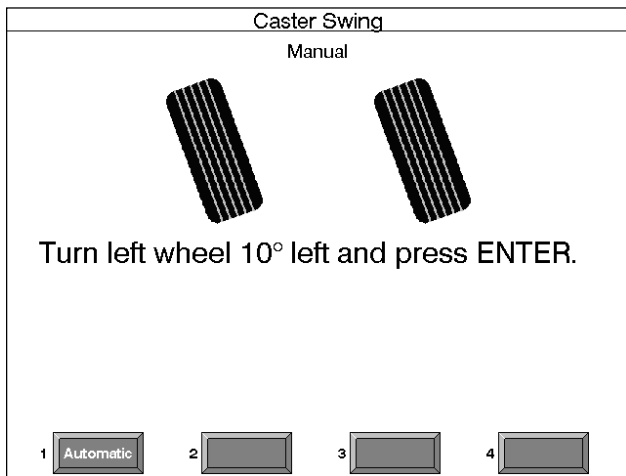

.....
TIP: Most vehicles step through the automatic caster swing mode without a hitch. If a problem is experienced, try switching to the manual mode - there is no difference in accuracy. Also, even if the aligner toe system is out of service the 10° turn point can be obtained from the rack turntables.

Performing a Wheel Alignment ... continued

Turn 10 degrees left -- after starting out with the front wheels facing straight ahead, the screen will change to indicate a turn to 10 degrees left. As the turning angle nears 10 degrees the "stop light" will change from green to yellow. When the wheels reach exactly 10 degrees the "stop light" indicator will change to red and the wheel graphic will change to green, meaning the measurement has been taken.

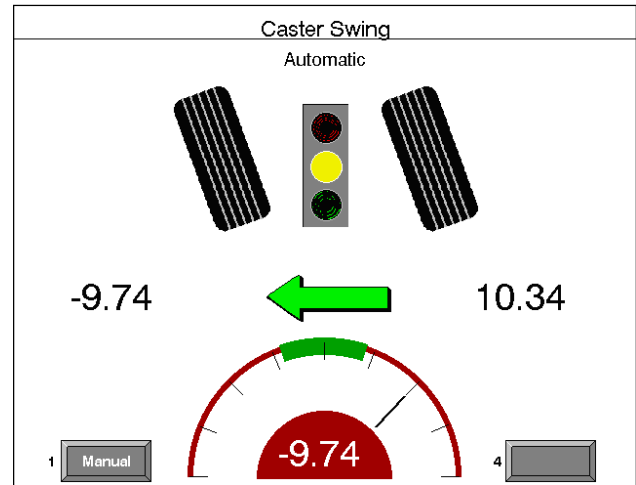

Turn 10 degrees right -- the screen will change to indicate a turn past straight ahead to 10 degrees right. The "stop light" will behave as above as the 10 degree angle is approached. The wheel graphics will change to green as the measurement is taken.

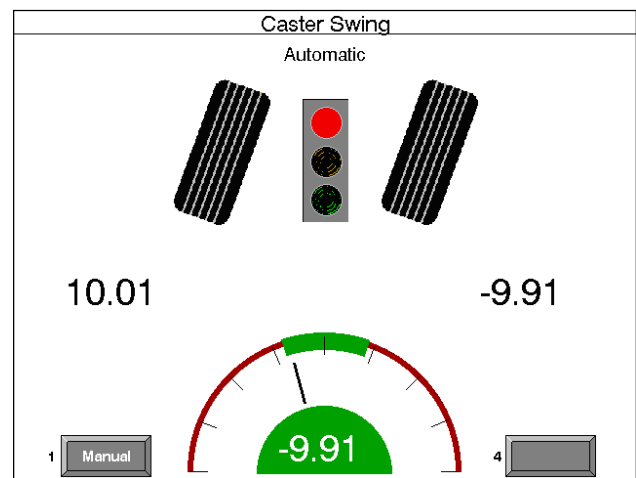

.....

TIP: Improving caster measurement accuracy:

- > *Operator variations during sweep* -- some common things are pulling/pushing the wheel differently and failure to reach the 10 degree mark exactly and hold steady until the measurement is taken. Some of these variations can be minimized by utilizing a brake pedal depressor during the caster sweep to ensure the wheels do not roll or rock during the turns. In addition, utilizing the steering wheel to make the turns will take the operators hands and arms away from the measurement process.
- > *Vehicle suspension/steering variations* -- if the vehicle has play or looseness in suspension and/or steering components, this can affect the reaction and tilt of the wheel during turns.
- > *Turntable/Rack condition* -- the condition of the turntables is critical. They must be free moving and flat with all bearing in place. Also, the vehicle wheels must be positioned in the center of the turntables to ensure flatness during the turn.

.....

Steer Straight Ahead -- after the caster angle is measured through sweeping the wheels, it is necessary to return to a straight ahead position for measuring the camber and toe angles. Follow the arrow direction until the "stop light" indicators and the reverse colors changing of the wheels graphic indicates the wheels are pointing straight ahead.

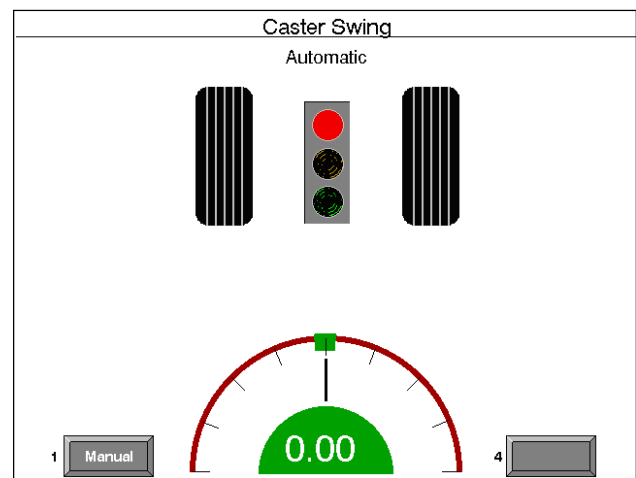

Performing a Wheel Alignment ... continued

Front Diagnostics			
	Left	Right	
Caster	Unstable Steering	Unstable Steering	
Camber	No problems detected	No problems detected	
Toe	Outside wear	Outside wear	
1	2	3	4

Advanced Diagnostics

Advanced diagnostics is a troubleshooting tool that takes the alignment measurements, compares them to manufacturers specification, and describes potential vehicle problems. The alignment computer samples all the readings and makes a conclusion of a potential problem. This diagnostic screen for the front and rear of the vehicle can be accessed by pressing soft-key #4 "Complaint" on any readings screen and the "Advanced diagnostics" from the Driver Complaint Menu. Press Enter to move through the diagnostics functions for the front and rear of the vehicle. If desired, Advanced Diagnostics can become part of the "alignment path" by using the proper Setup options (see page 34).

Left Side Bent Parts Diagnostics			
Note: Worn or fatigued suspension components including incorrect ride height may cause inaccurate diagnosis of bent parts.			
Problems: If camber can't be adjusted to spec Check for bent or damaged parts using list below:			
Check:			
Short/Long Arm	MacPherson Strut	I-Beam	
Knuckle/Spindle	Knuckle/Spindle/Strut	Knuckle/Spindle	
1	2	3	4

Bent Parts

The suspension angles SAI, Included Angle, and camber have been used for years to diagnose bent parts. These angles were manually charted on paper with the technician making the conclusion based on his measurements. This technique has been incorporated into the Visualiner to utilize the power of the computer system. Angles are measured and compared with vehicle specifications to determine if a problem exists. An on-screen readout informs the technician which components are most likely bent or damaged. While in the "Advanced diagnostics" section of the Driver Complaint Menu, keep pressing Enter to view the Bent Parts display for the left and the right sides.

NOTE: Operator must perform an SAI/caster swing and specifications must be entered before an evaluation can be made. If these Advanced Diagnostics screens are made part of the alignment path, it is recommended to configure the "Alignment Order" to measure Caster/SAI simultaneously instead of caster only. See page 31 for details setup details.

Performing a Wheel Alignment ... continued

Step 13. Rear Readings

After the caster sweep procedure is completed, the Rear Readings screen appears. This screen displays, both in meter and numerical format, the angle measurements and information needed to determine if corrections are necessary. The display is divided into three rows: **Camber**, **Toe** and **Thrust Angle**. The columns represent the left and right side of the vehicle. The Camber and Toe meters have minimum, preferred, and maximum specifications along the top, a digital readout of live readings, and a color coding to indicate the relationship of live values to specification. Grey meters indicate no specification has been entered for this angle. Red meters indicate the angle is beyond manufacturer's specification. Green meters indicate the live values are within the specification.

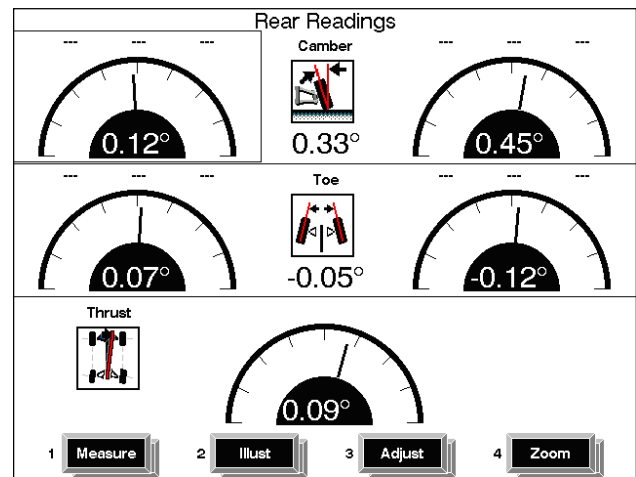

Cross Value / Total Toe -- the digital readout in between the camber meters indicates cross values (side-to-side), the difference between left and right readings. This cross value is important on many vehicles for proper handling. The digital readout between the left and right toe meters indicates the Rear Total Toe (the sum of individual toe).

Soft-keys -- two sets of soft-keys are available on the Rear and Front Readings screens. These keys can be toggled by using the "☰" key.

- #1 - "Measure"** - menu for measuring additional angles
- #2 - "Illust"** - to assist the technician, an illustration of each angle adjustment is displayed
- #3 - "Adjust"** - accesses menus to assist the technician with angle corrections
- #4 - "Zoom"** - brings a highlighted meter to full screen

Toggle #1 - "Print" - accesses the print and save data menu

Toggle #2 - "Edit" - allows editing of specifications, customer information, and inspections

Toggle #3 - "Setup" - allows alteration of any Setup item during the alignment process

Toggle #4 - "Complaint" - accesses the Driver Complaint menu for additional diagnostic help

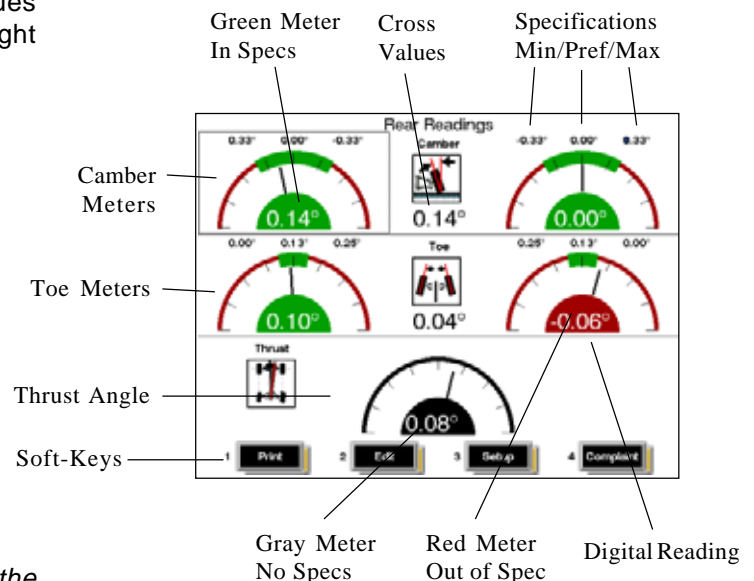

Performing a Wheel Alignment ... continued

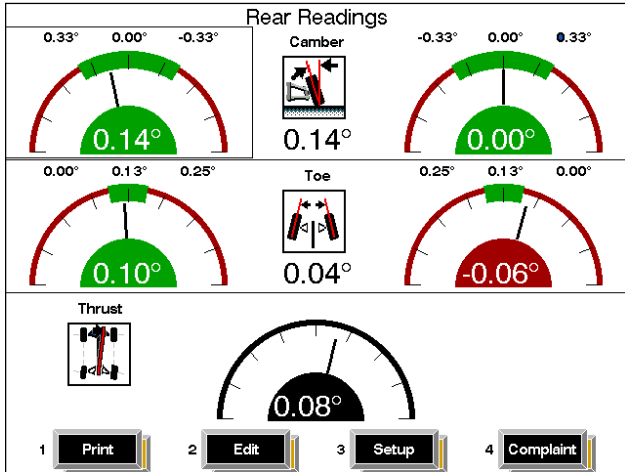

Rear Readings Meter Displays -- the camber, toe, and thrust angle readings are "live" and can be referenced while making adjustments on the vehicle. As the adjustment is made, the meter needle will move and the digital readout will change. Adjust the vehicle until the desired readings are obtained. As the readings move from out of specification to within specification, the meter center color will change from red to green. Additional adjustment assistance for many vehicles is obtained through the Adjust Menu (soft-key #3).

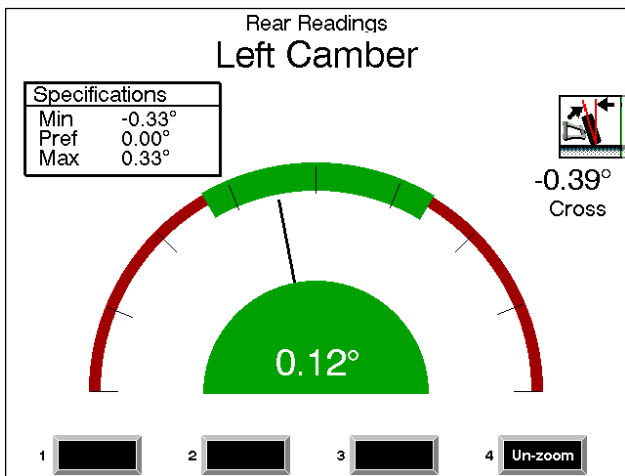

Zoom -- for easier viewing of any individual meter move the white highlight box to the desired meter with the arrow keys, then press Zoom. The meter will occupy the whole screen. The zoom screen contains the specifications and shows a cross value for reference to the other side. While zoomed, the arrow keys will navigate the other meter displays. Press "Unzoom" to return to the complete Rear Readings screen.

After viewing the rear readings and, if necessary, making any angle corrections press "Enter" to move to the Front Readings.

Prepare for Front Readings

1. Level and lock steering wheel.
2. Level all heads.
3. Press ENTER.

Step 14. Prepare for Front Readings

Before front readings are displayed it is necessary the level the steering wheel and lock it in place using the steering wheel holder supplied with the Visualiner. In addition, all measuring heads must be leveled and locked in place. Once these steps are completed press Enter to move forward.

Performing a Wheel Alignment ... continued

Step 15. Front Readings -- the look of the Front Readings screen is similar to the rear. Measured **caster** is displayed with the top meters. Note this reading is represented by an icon showing the caster reading to be frozen since caster is not a live reading. **Camber** meters are located in the middle of the screen and **toe** meters are at the bottom. Camber and toe are "live" displays which can be referenced while making adjustments. The left wheel is represented on the left meter and right wheel on the right. When measurements are within specification, the center portion of the meter will turn green. If red is displayed, the readings are outside of specifications. Cross values are displayed between the caster and camber meters, while total toe is displayed between the individual toe meters.

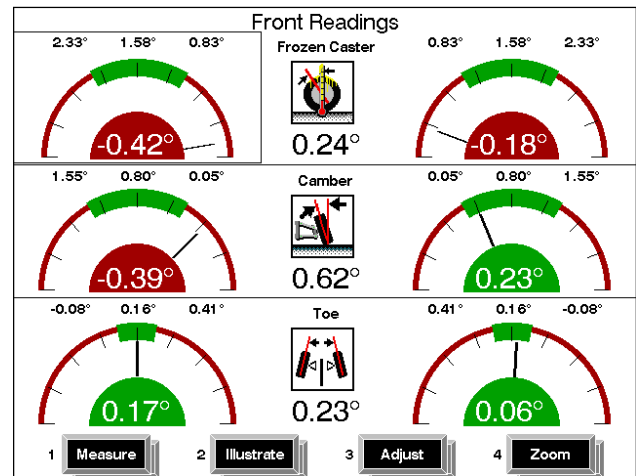

Soft-keys -- two sets of soft-keys are available on the Rear and Front Readings screens. These keys can be toggled by using the "☐" key.

- #1 - "Measure"** - menu for measuring additional angles
- #2 - "Illust"** - to assist the technician, an illustration of each angle adjustment is displayed
- #3 - "Adjust"** - accesses menus to assist the technician with angle corrections
- #4 - "Zoom"** - brings a highlighted meter to full screen

- Toggle #1 - "Print"** accesses the print and save data menu
- Toggle #2 - "Edit"** - allows editing of specifications, customer information, and inspections
- Toggle #3 - "Setup"** - allows alteration of any Setup item during the alignment process
- Toggle #4 - "Complaint"** - accesses the Driver Complaint menu for additional diagnostic help

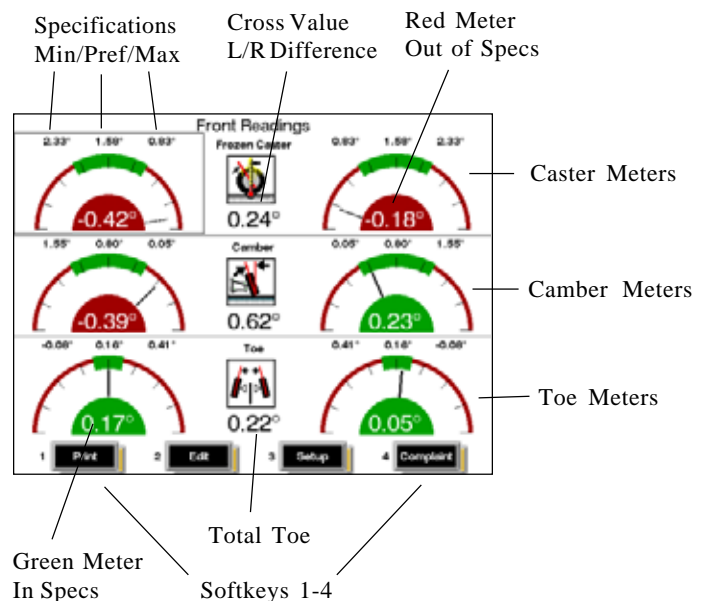

Front Angle Adjustments -- the Camber and Toe angle values displayed on the meters are live and can be viewed while making corrections on the vehicle. Caster is a "frozen" value. For assistance with caster adjustments, along with other functions that make camber easier on many vehicles, press soft-key #3 "Adjust". The Adjust Menu is covered in detail on page 71.

Performing a Wheel Alignment ... continued

Rear Toe Illustration

Adjustable eccentric cam (toe or camber adjustment)

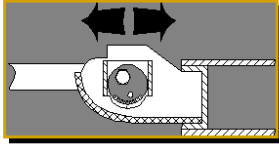

To adjust individual toe or camber, loosen pivot bolt and rotate eccentric cam until desired reading is achieved. Index will designate whether this adjustment is camber or toe.

Parts required - NONE.
Modifications required - NONE.
Special tool required - NONE.

--36--

[] [Animate] [] []

Adjustment Illustrations -- illustrations of angle adjustment possibilities can be viewed by pressing the soft-key #2 "Illust". If more than one picture is available (separate camber, caster and toe adjustments) the "Enter" key can be used to page through the illustrations. The "Page Back" key is used to move backwards. If an illustration for a particular angle does not appear, it is likely the vehicle has no provision for adjustment. To return to the readings screen continue to page back or press the "NO" key on the head, remote, or keyboard.

Front Camber Illustration

Dual Frame Slots/Ball Joint Cams (Upper control arm)

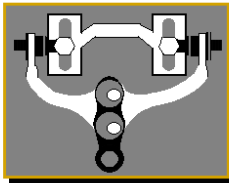

LARGE Caster/Camber Correction.
To DECREASE Caster, move FRONT of control arm IN and REAR OUT equally.
To INCREASE Caster, move FRONT of control arm OUT and REAR IN equally.
To DECREASE Camber, move control arm IN at both front and rear equally.
To INCREASE Camber, move control arm OUT at both front and rear equally.
SMALL Caster/Camber Correction.

To correct Camber, loosen and rotate outer ball joint cam.
To correct Caster, loosen and rotate inner ball joint cam.

Parts required - NONE.
Modifications required - NONE.
Special tool required - Tools vary with model.

--82--

[] [Animate] [] []

The Adjustment Illustrations are a powerful tool to assist the alignment technician. In addition to the picture, written instructions are provided plus information on any additional parts, special tools, or modifications that may be required.

Animated Graphics (CD-ROM only) -- use soft-key #2 "Animation" to view an animated version of the adjustment procedure. This can be a further aide to understanding what needs to done on the vehicle to correct any alignment angle. Press "Enter" to return to the illustrations or wait until the animation stops and automatically returns you to the illustrations display.

Front Readings
Right Camber

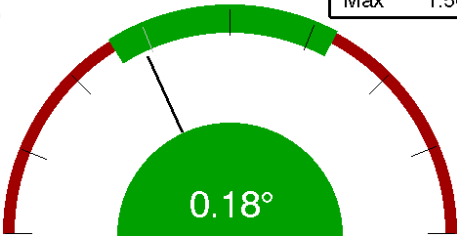

Specifications	
Min	0.00°
Pref	0.80°
Max	1.50°

-0.61°
Cross

0.18°

1 [] 2 [] 3 [] 4 [Un-zoom]

Zoom -- for a zoom image of one meter move the highlight box to the desired meter with the arrow keys, then press soft-key #4 "Zoom" for a close up look. Press #4 "Unzoom" to return to the full screen display.

.....

TIP: When adjusting the vehicle, particularly on the rear, you can increase the size of the meter to full screen for easier viewing by pressing softkey #4 - "Zoom". Once any meter is zoomed, you can move to other meters using the up/down and left/right arrow keys.

.....

Performing a Wheel Alignment ... continued

Step 16. All Readings

This is a summary display that will show both the rear and the front readings at the same time. If vehicle specifications have been entered, the digital displays will be red (out of specification) or green (within specification). In addition, this screen will show, if measured, Included Angle, SAI, Toe Out on Turns, and Setback. Front and rear camber and toe readings are live from this screen. This display is one of the three "Readings" displays that are available. These three displays will be in a "loop" at the end of the programmed alignment sequence. If the "Front Readings" are displayed the "Rear Readings" and "All Readings" can be displayed by pressing the "Enter" key. Available soft-keys are:

#1 Print -- when selected will display the print/save menu

#4 veh_dims -- this is a feature only available with the Visualiner Surround Sensor SV8 model. See the supplemental SV8 manual for details.

If measurements or adjustments have to be made, use the "Enter" key to go to either the front or the rear readings display.

The icon in *Figure 9* may appear on any of the readings screens. This icon indicates the measuring head is not communicating with the main computer. If this icon appears, check the cable connections and refer to the service guide section of this manual.

The icon in *Figure 10* indicates a blockage of the toe signal on the optical measuring heads. Check for any item that may be obstructing the line of sight between all heads and refer to the service guide section of this manual.

This completes the Programmed Alignment procedure to obtain all basic alignment readings.

	All Readings		Current rack -- A 44
Front			
Caster	1.5°	0.2°	1.7°
Camber	0.0°	0.3°	0.3°
Toe	9/32"	9/16"	9/32"
Included angle	4.7°		9.1°
SAI	4.7°		8.7°
Toe out on turns	---		---
Max turns	---		---
Setback		0.2"	
Rear			
Camber	-1.1°	3.0°	1.9°
Toe	3/32"	1/4"	5/32"
Thrust angle		-0.1°	
Setback		-0.0"	
Caster			
- 95 HONDA ACCORD			
1	Print	2	
3		4	Veh_dims

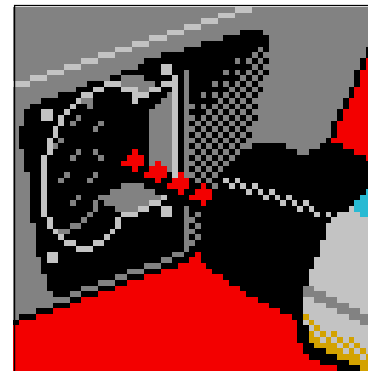

Figure 9

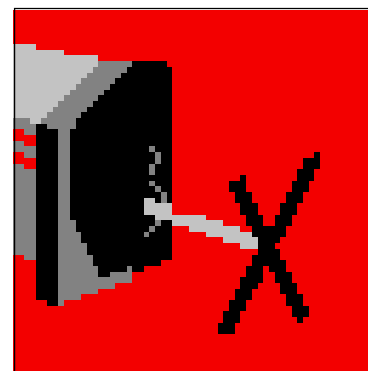
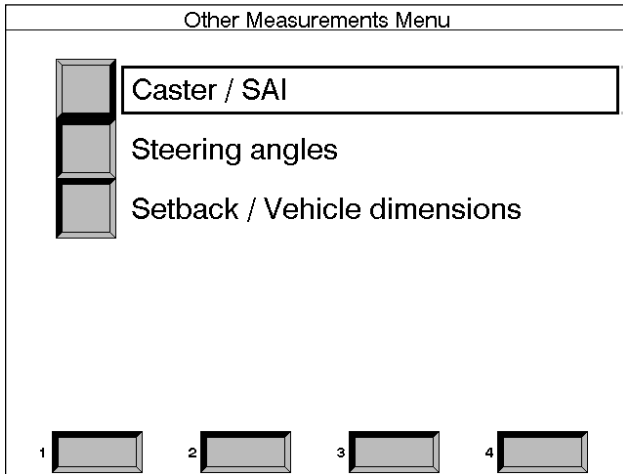

Figure 10

Measuring Other Angles



Other Measurements Menu

Press soft-key #1 "Measure" on the front or rear readings screens for additional angle and diagnostic measurements. The choices are Caster / SAI, Steering angles, and Setback / Vehicle dimensions.

Note: Vehicle dimensions capability is only available with the Visualiner Surround Sensor (SV8) model configuration.

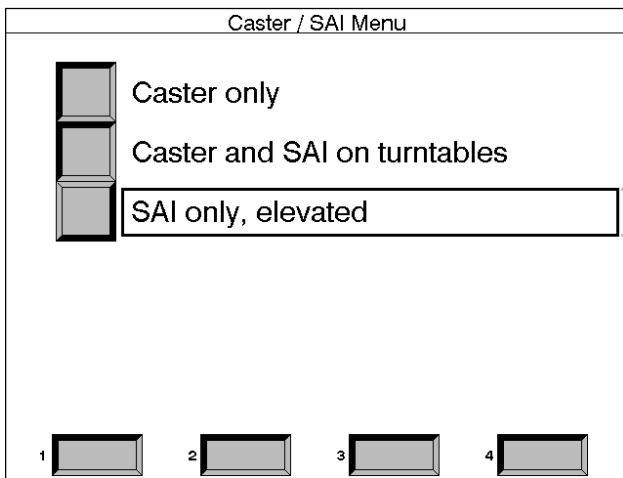

Caster / SAI Menu -- choices are:

Caster measurement only -- to repeat the caster sweep to obtain a new caster value

Caster and SAI on turntables -- allows measurement of caster and SAI in one sweep

SAI only, elevated -- measures SAI with the vehicle wheels elevated

Steering Axis Inclination (SAI) and Included Angle (IA)

-- these angles are powerful tools in diagnosing bent or damaged suspension parts. A bent spindle, control arm, strut, frame mounts, or a cradle shift problems can be identified. SAI is measured either vehicle weight loaded on the turntables or with the front wheels elevated. Included Angle is not actually an angle defined on the vehicle -- it is a mathematical formula. By definition, $IA = SAI + CAMBER$. Most late model vehicles have a specification for Included Angle, and a few for SAI. Compare the measured values to spec, but also compare side-to-side (cross) differences.

.....

TIP: Cross differences for Included Angle should not exceed 1 to 1.5 degrees for most vehicles. If a high cross value is discovered, it may be creating a pull condition. Generally, the damaged part is on the side with the lower IA reading.

.....

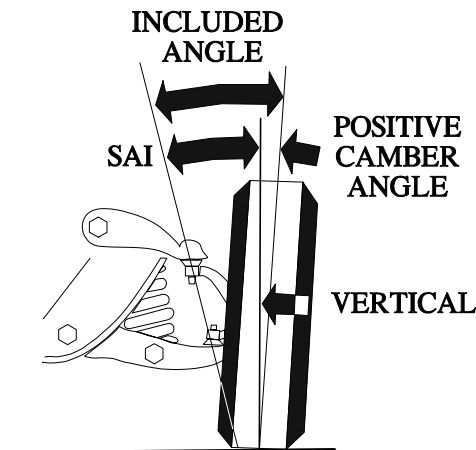

Measuring Other Angles

Measuring Steering Axis Inclination (SAI) and Included Angle -- the measurement method for SAI and Included Angle is similar to the Caster measurement. The wheels are swung through a 20 degree turn and the change in wheel tilt is measured. SAI can be measured either on the turntables or with the front wheels elevated. For accurate results follow the on-screen instructions carefully.

SAI and Included Angle, Elevated

Caster, SAI, Included Angle on Turntables

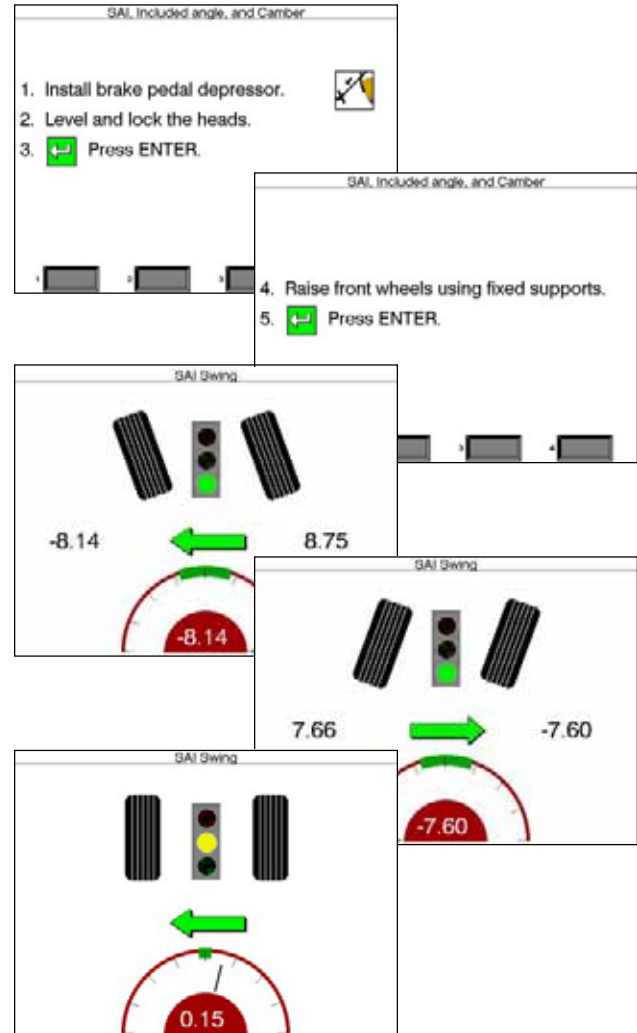
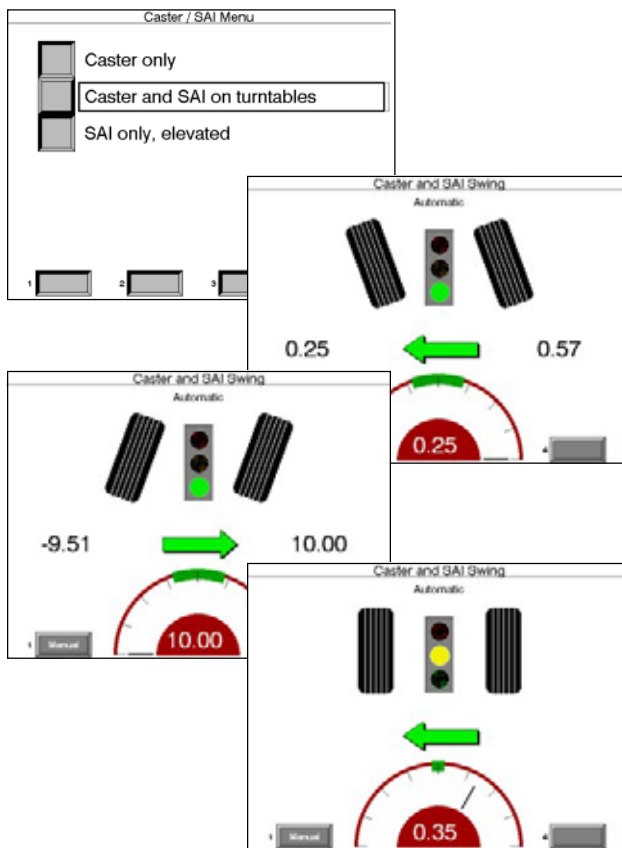

SAI / IA Display -- when SAI / Included Angle measurement is completed the results are displayed on the **All Readings** screen and are available for printout. These angles are useful for diagnosing bent or damaged parts. The Visualiner contains an Advanced Diagnostics feature that can assist with this diagnosis (see page 60).

	All Readings		Current rack - A. 44
Front			
Caster	1.5°	0.2°	1.7°
Camber	0.0°	0.3°	0.3°
Toe	9/32"	9/16"	9/32"
Included angle	4.7°		9.1°
SAI	4.7°		8.7°
Toe out on turns	---		---
Max turns			
Setback		0.2°	
Rear			
Camber	-1.1°	3.0°	1.9°
Toe	3/32"	1/4"	5/32"
Thrust angle		-0.1°	
Setback		-0.0°	
Caster			
- 95 HONDA ACCORD			
1	Print	2	3
			4 Veh_data

Measuring Other Angles

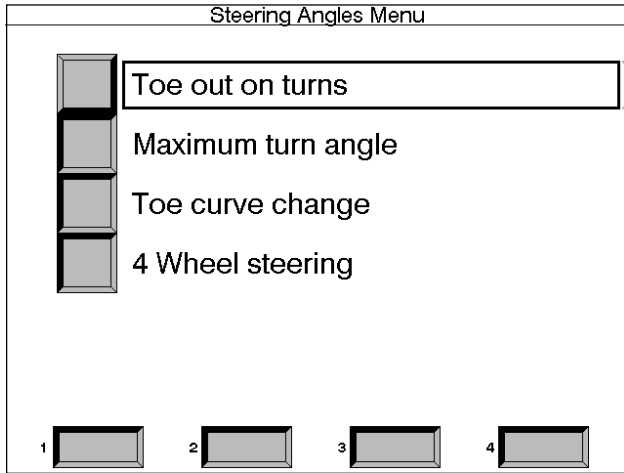

Steering Angles Menu -- choices are:

- Toe out on turns -- used for diagnosing damaged steering components
- Maximum turn angle -- used to measure and adjust maximum turn on many vehicles
- Toe curve change -- used for diagnosis of steering and suspension problems
- 4 Wheel steering -- when a Honda or Mazda with 4 wheel steering is selected this option outlines the steps for proper alignment

Toe Out on Turns (or Turning Radius)

Toe out on turns is another diagnostic measurement that is valuable in troubleshooting steering and handling problems.

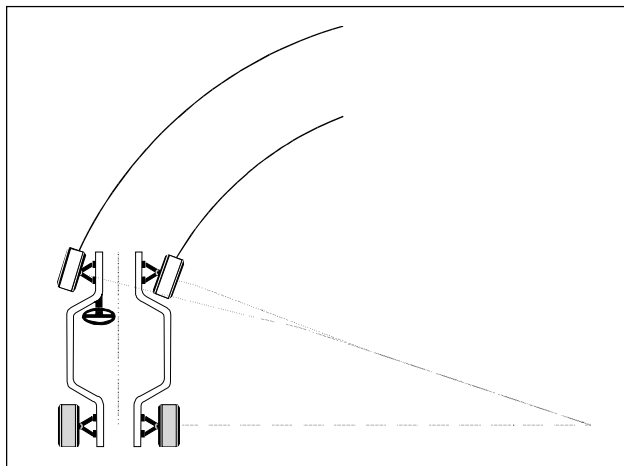

TOOT or Turning radius, as it is commonly called, is the difference in the turning angle between the inside and the outside wheel.

TOOT is measured using the turntable scales of the alignment lift. On many vehicles, the manufacturer specifies the inside wheel to be turned 20 degrees. Other vehicles specify the wheel be turned to a different angle, usually "full lock". This is possible with the Visualiner by selecting "Other turn" on the menu.

Note: the Visualiner vehicle database does not contain specifications for toe out on turns. Refer to an alignment specification book or the vehicle's shop manual.

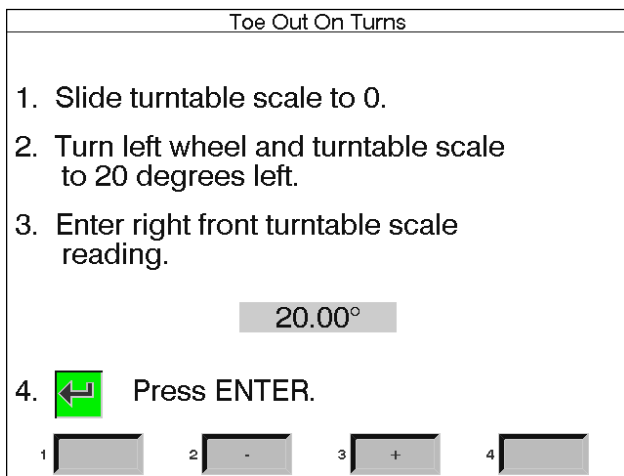

The Toe Out On Turns measurement is not automatic. Using the turntable scales, identify the inside wheel turn angle, then read the outside wheel turn angle and enter the information into the computer. For best results follow the on-screens carefully. TOOT results will appear on-screen and are available for printout.

.....
TIP: Toe Out on Turns problems always indicate a bent or damaged steering arm, with the problem wheel being the one on the outside of the turn.

Measuring Other Angles

Maximum turn angle -- this program allows the measurement of the "full lock" or maximum turn in each direction. It uses the turntable scales and provides the ability to enter the results in the computer for viewing and printing. Consult an alignment specification manual or shop service manual for manufacturers procedures and specifications.

Maximum Turns

- Slide both turntable scales to 0.
- Turn left wheel and turntable scale to max angle left.
- Enter left front turntable scale reading.
- Press ENTER.

42.0°

1 [] 2 [] 3 []

Maximum Turns

	Inside	Outside
Left Turn	42.0°	39.0°
Right Turn	44.0°	41.0°

1 [] 2 [] 3 [] 4 []

Toe Curve Change -- this feature allows measurement of individual wheel toe change as the suspension system goes through jounce and rebound (spring compression and expansion). An excessive amount of toe change can cause premature tire wear. A large change on only one side can cause "bump steer", a dangerous condition causing the vehicle to rapidly change directions when bumps are encountered. While there are no specifications for the amount of change, a comparison of left and right wheels can assist in diagnosing defective steering system components. Follow the on-screen instructions carefully.

Toe Curve Change

- Raise or lower vehicle by lifting/pulling the frame or unibody 60 mm (2.3 inch)
- Press ENTER.

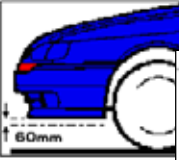

60mm

1 [] 2 [] 3 []

Toe Curve Change

	Left	Right
Original toe	0.30°	0.60°
Raised/lowered toe	0.30°	0.60°

Toe change



0.00°



0.00°

1 [] 2 [] 3 [] 4 []

.....

TIP: On cars with rack and pinion steering, a bump steer condition is usually created by worn rack mounting bushings that allow the entire rack to shift when bumps are hit. Some GM cars (80's Camaro & Firebird) have slotted idler arm mounts to allow correction of toe curve change problems.

.....

4 Wheel steering -- this feature provides help for wheel alignment on Honda and Mazda with the 4WS option. If one of these vehicles is selected during entry of specifications, this help screen will appear following the caster sweep to insure proper procedures are followed.

Honda Four Wheel Steering

Honda 4ws alignment procedure:

- Remove the No. 32 (brake light) fuse from the under-hood relay box.
- Measure front caster and adjust if necessary, then equalize front toe.
- Measure front camber and adjust if necessary.
- Remove the gear box cap bolt and install the rear steering center lock pin.
- Measure rear camber and adjust if necessary.
- Check steering wheel alignment. If it is misaligned by more than 6 degrees, remove the steering wheel and reposition it.

WARNING! FOLLOW MANUFACTURERS RECOMMENDED PROCEDURES ON AIR BAG EQUIPPED VEHICLES.

- Remove the rear steering center lock pin and reinstall the gearbox cap bolt.
- Center and secure steering wheel using a steering wheel holder.
- Measure rear toe and adjust if necessary.
- Measure front toe and adjust if necessary.
- Remove the steering wheel holder.
- Reinstall the No. 32 fuse and test drive the vehicle to check for steering wheel alignment.

WARNING! IF STEERING CENTER LOCK PIN IS NOT REMOVED, DAMAGE TO STEERING SYSTEM MAY RESULT WHEN CAR IS DRIVEN.

1 [] 2 [] 3 [] 4 []

Measuring Other Angles

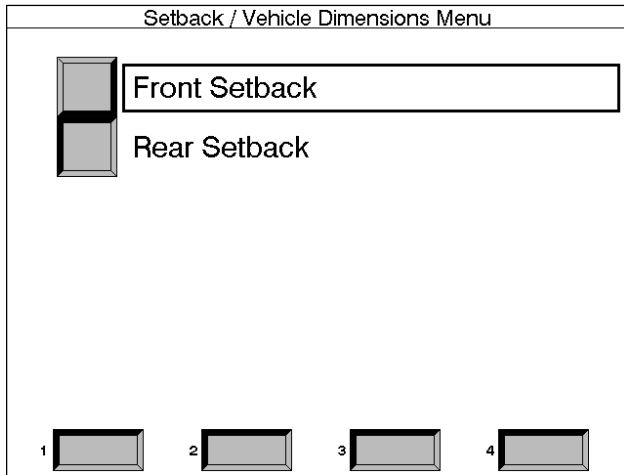

Setback / Vehicle Dimensions -- setback occurs when one wheel on an axle is not even with the other. Setback problems are mostly associated with vehicles involved in collisions.

Note: The Vehicle Dimensions feature is available only with the Visualiner Surround Sensor SV8 model. See the supplemental manual for instructions on this feature.

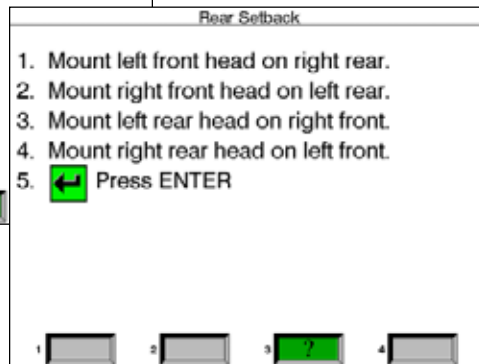
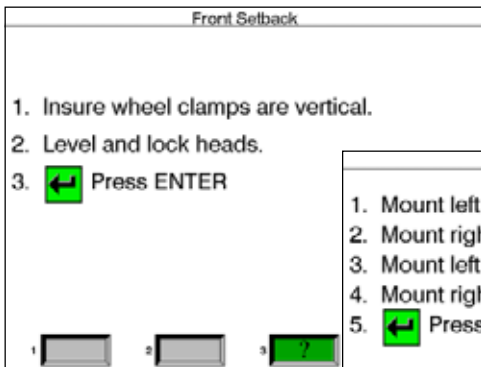
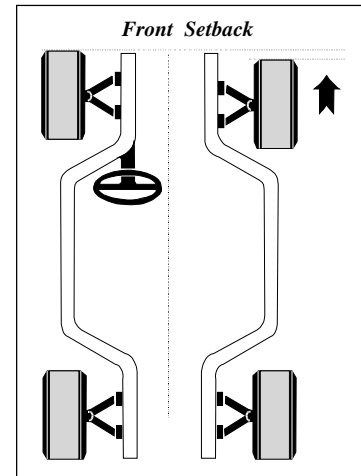

Setback can be measured on either the front or rear of the vehicle. On-screen instructions must be followed carefully. When rear setback is measured, the measuring heads must start out on the rear of the vehicle (not the case with SV8 model), runout compensation performed, then the heads are returned to their normal positions and runout is repeated.

	Front	All Readings	Current rack - A 4
Caster	1.5°	0.2°	1.7°
Camber	0.0°	0.3°	0.3°
Toe	9/32"	9/16"	9/32"
Included angle	4.7°	9.1°	9.1°
SAI	4.7°	8.7°	8.7°
Toe out on turns	---	---	---
Max turns	---	---	---
Setback		0.2"	
Rear			
Camber	-1.1°	3.0°	
Toe	3/32"	1/4"	
Thrust angle		-0.1°	
Setback		-0.0°	
Caster	---	---	
- 95 HONDA ACCORD			

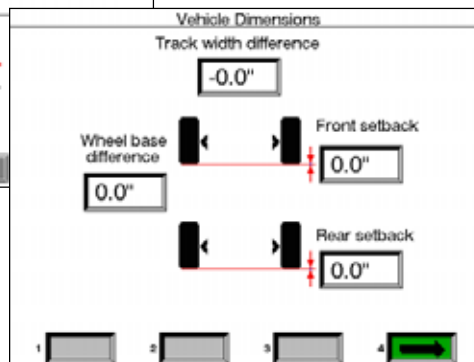

The results of setback measurements are displayed only on the All Readings screen and are printed during the alignment results printout. With the SV8 models, setback is displayed on the vehicle dimensions screen which also shows wheelbase and track width dimensions. Setback can be displayed in inches or millimeters, selectable in the Units of Measure setup.

Adjustment Assistant

Adjustment Assistant Menu -- access this menu from the front or rear readings screen by pressing soft-key #3. There are numerous features designed to improve the efficiency and effectivity of the alignment technician in performing vehicle adjustments. Menu choices are:

A-Arms -- for vehicles whose caster and camber adjustments are located on the suspension A-Arm, this selection allows both angles to be corrected simultaneously

Caster and/or camber -- several different options available to assist with these angles, including live caster

Total toe (drag link) -- helps with vehicles having a single toe adjuster

Shim information -- many front wheel drive cars use a shim on the rear axle/spindle to adjust camber and/or toe. This program determines the proper shim to use

Cradle adjustment -- assist with the adjustment of the engine cradle on many front wheel drive cars

A-Arm Adjust -- many vehicles have adjustment provisions for caster and camber located on the suspension A-Arm, either upper or lower. The adjustments may be made with shims, eccentric cams, or

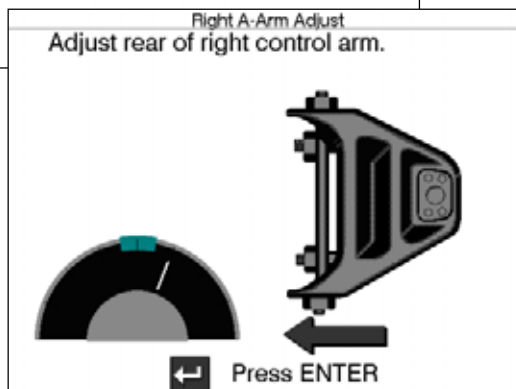
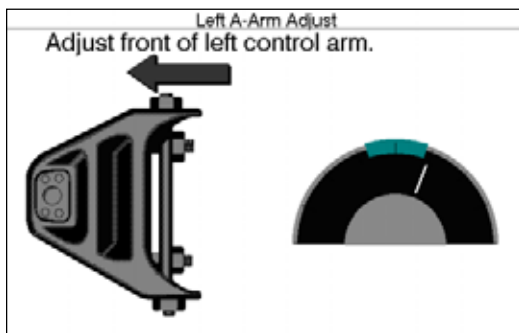
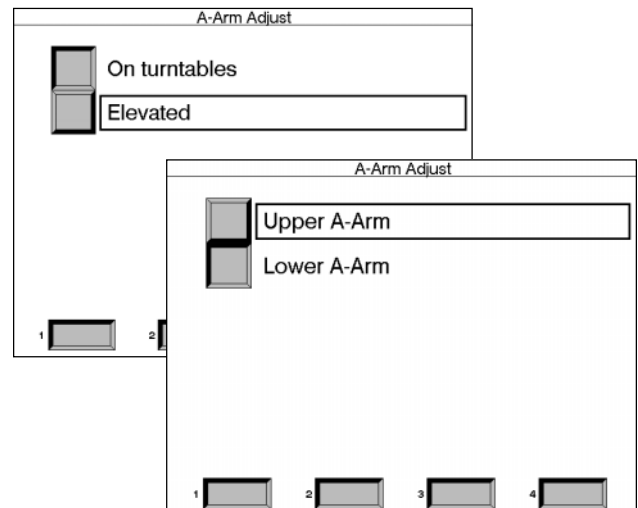
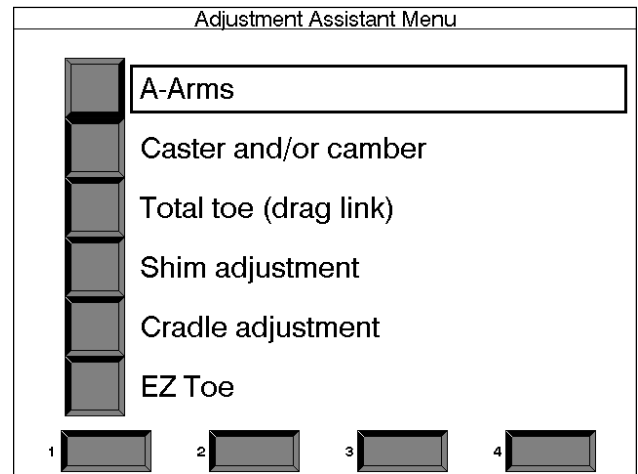

slots in the frame. Both angles are easily corrected to specification using this screen. The first step is telling the Visualiner the location of the adjustable A-Arm and whether the corrections will be made on the turntables or elevated. Next, apply the brake pedal depressor (important) and follow the on-screen instructions.

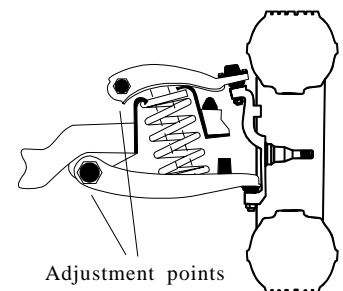

Adjustment points can be on upper or lower control arm

Adjustment Assistant ... continued

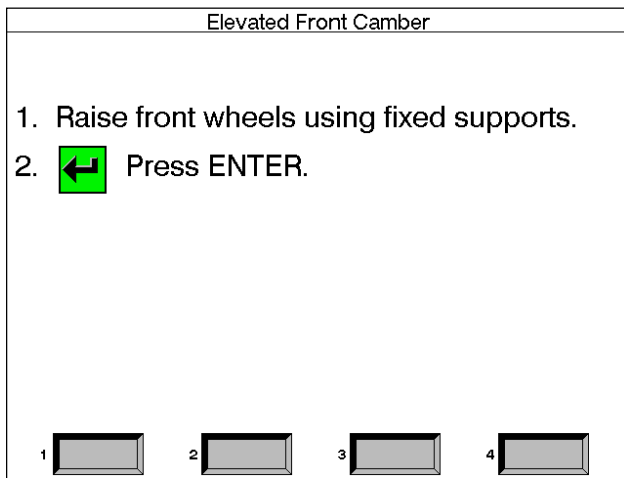
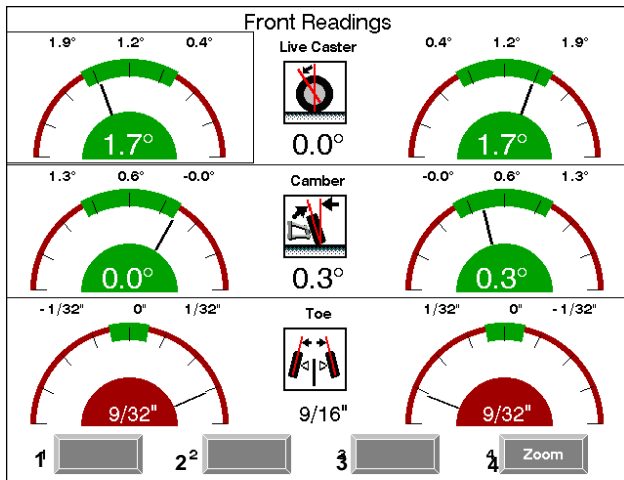
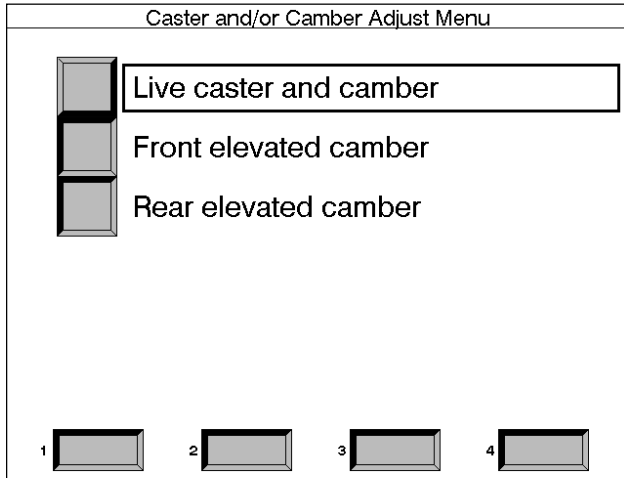

Adjust Caster / Camber Menu -- this menu contains items to assist with angle adjustments on all types of vehicles. Choices are:

Live Caster and camber -- this item can be used on the turntables or elevated and gives live caster, camber and toe readings

Camber elevated -- usable on the front or rear, this function retains the camber value after the wheels are raised

Live Caster and Camber -- after selecting on turntables or elevated, a screen very similar to the standard Front Readings display appears. The major difference is the caster reading - it is live instead of frozen. Caster and camber can be adjusted while viewing this screen - for example, caster change will be shown as a strut rod is lengthened or shortened. The toe readings shown are for reference. Upon leaving this screen by pressing Enter, the standard Front Readings screen will reappear, allowing for the final adjustment of front toe.

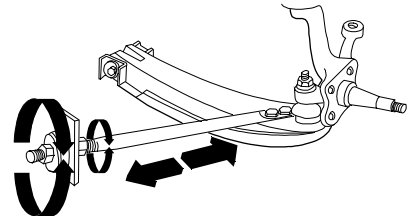

Camber Elevated -- for either the front or rear wheels, this feature allows the wheels to be elevated while retaining the measured camber values. This allows accurate correction of camber without vehicle weight inhibiting the adjustment process. This would be useful for tapping down a wedge on a strut vehicle. The adjustment screen looks very similar to the live caster/camber screen above, with the exception of caster, which is frozen. When completed with the adjustment, press Enter, and when the vehicle is lowered camber will be at specification. Pressing the "Back Page" key from the Adjustment Assistant Menu will return the program to the front or rear readings screen.

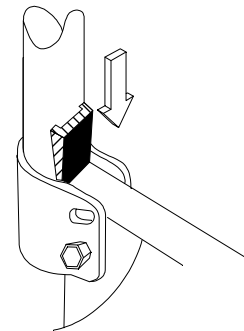

Adjustment Assistant ... continued

Total toe (drag link) -- the steering linkage on some trucks has a single total toe adjuster along with a drag link adjuster to correct the steering direction and straighten the steering wheel. This menu item will allow simple and accurate adjustments to be made. From the Adjustment Assistant menu select Total toe (drag link). The technician will be prompted to choose adjust with the tie rod or the drag link by selecting soft-keys 1 or 2.

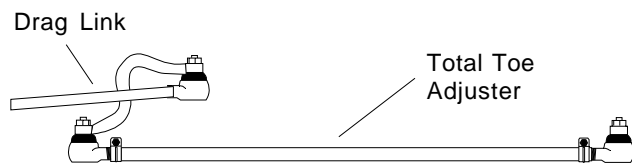

Follow the on-screen instructions. First, steer the front wheels to equalize toe, press Enter. Next adjust the single tie rod to specifications while observing the meter, press Enter. Then, straighten and lock the steering wheel and adjust the drag link sleeve until the steering direction is straight ahead, as indicated on the meter display.

Shim Adjustment -- many front wheel drive vehicles utilize aftermarket shims to correct rear camber and/or toe. This correction is achieved by placing the shim between the rear axle and the spindle. The Visualiner has several different aftermarket shim manufacturers available, each of which must be setup prior to use during the alignment program (see page 33). Consult the shim manufacturer's catalog for detail application information.

When a vehicle that utilizes rear shims is accessed from the specification database, the technician can use the Visualiner to determine the proper shim to correct a rear misalignment. From the Adjustment Assistant Menu choose "Shim Adjustment". The choices are then "Shim information" and "EZ Shim", a program which features the rotating, single adjustment shim manufactured by Specialty Products .

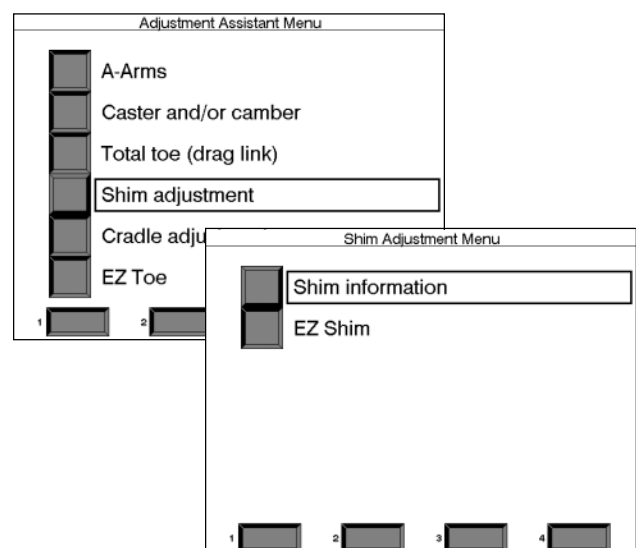
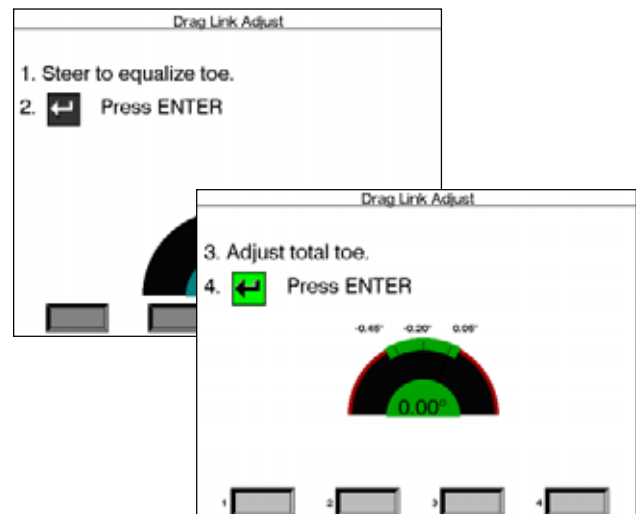
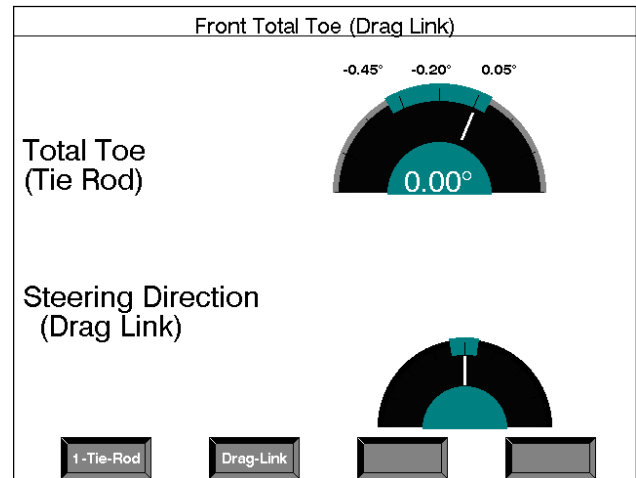

Adjustment Assistant ... continued

Rear Shim Adjustment Summary				
93-95				
LESABRE	Left		Right	
	Camber	Toe	Camber	Toe
Measurement	-1.1°	3/32"	1.9°	5/32"
Specification	-0.3°	1/32"	-0.3°	1/32"
Change needed	0.8°	- 1/16"	-2.2°	- 5/32"
Shims available:				
Shimco/NAPA	5500-D	NA	NA	
AlignTech	3383			
Specialty Products	71826	71820	71828	71822

Shim Information -- At this point the computer will examine the live rear camber and toe readings, compare them to preferred specification, and calculate the amount of change needed. It will then recommend the shim needed to make this correction.

The first screen that appears is the "Rear Shim Adjustment Summary". All shim manufacturers that have been selected in "Setup" are shown. The initial alignment reading, specification and the needed change will be indicated along with the part number of the shim. To view more information about placement of the shim, place the highlight box around the desired manufacturer and press Enter.



Shimco International - Right Side

93-95 LESABRE

Part Number

- Center and align the shim size index mark with the index mark on the screen.
- Mark the shim at the 12 o'clock position. Use vertical line as a reference.
- Install shim with the mark in the 12 o'clock position.
- Use a torque wrench to tighten the sprocket bolts.

May be used with anti-lock brakes if the sensor is mounted in the carrier hub.

Shimco shim selector patented computer (U.S. Patent Nos. 5,007,858 and 5,116,155)

1 Left/Right 2 [] 3 [] 4 []

AlignTech - Right Side

93-95 LESABRE

Part Number

REMOVE SHADED AREA AT TOP OF SHIM.

Break out red tabs

Shimco shim selector patented computerized program used by permission (U.S. Patent Nos. 5,007,858 and 5,116,155). Install shim with numbers facing toward you.

1 Left/Right 2 [] 3 [] 4 []

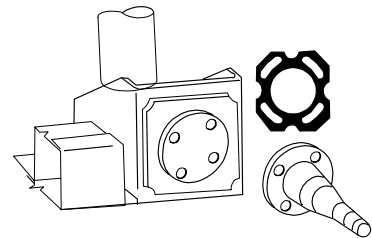

The displays shown here are for Shimco and AlignTech. The screens show the part number, a graphical presentation of proper installation orientation, and written instructions. After installation of the shims is completed press Enter, follow the instructions, and press the "Back Page" key to move from the Adjustment Assistant Menu to the Rear Readings screen.

EZ SHIM™

from the PRO ALIGNMENT SPECIALTY PRODUCTS

CHEVROLET CORSA (1993-95)

Part #: 7500 - Gray

Instructions

- End caps and lower plate to prep the sensor are shown on the left. Install them on the sensor. Mark with these numbers and maintain area.
- Using special guide arrows, from centerline, the shim has been side of the track) also use enough to break the connection, always cut from inside out, not for the left side, then the other side, unless noted.
- Make sure vehicle has correct adjustment area in all wheels.
- Insert shim into the sensor. Use the center on the shim. Mark [] area from the sensor. When reading done on the sensor use the numbers on the shim. Mark the sensor the number.
- Torque bolts at [] to [] torque at the correct edge of the shim in a correct pattern.

Press Esc for Adjustments, End To Exit

EZ Shim -- This program is designed by Specialty Products Co. as an assistant for properly using and installing their EZ Shim rear camber/toe angle correction product. The program automatically determines which one of the three colored shims is used for the vehicle, the amount of camber toe correction required, and the proper indexing of the shim. Once the calculation is completed, a picture of the shim is displayed with instructions for installation. On-screen instructions guide the operator through the steps.

Adjustment Assistant ... continued

Camber - Decreased
SAI - Increased
Incl'd Ang - Good

Camber - Increased
SAI - Decreased
Incl'd Ang - Good

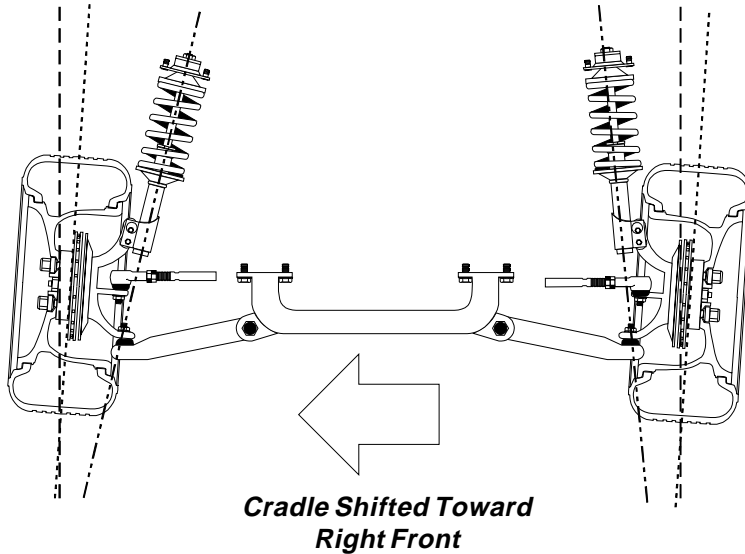

Cradle Adjust -- cradle adjustment is a growing necessity for many front wheel drive vehicles. Many front wheel drive vehicles are designed where the engine cradle also serves as the attachment point for the lower pivots of the suspension system. This assembly is bolted to the sub-frame as a unit from the bottom of the vehicle. The assembly must be properly aligned with the sub-frame to assure that front alignment is maintained.

A closer look at the assembly will show that the lower control arms are bolted to the cradle assembly. The control arm is attached to the spindle through the lower ball joint. The strut or upper pivot is attached to the upper end of the spindle and is attached to the upper body via the upper strut mount at the upper tower position to complete the suspension steering axis.

The engine cradle can be moved side to side, changing the camber and SAI angles. Prior to beginning a cradle adjustment, examine the left and right camber values. If one side has excessive positive camber and the other side excessive negative, this vehicle is a candidate for cradle adjustment.

Vehicles with cradle adjustment potential include:
 Ford Taurus / Mercury Sable, Lincoln Continental
 GM "W" Body (Lumina, Grand Prix, Cutlass, Regal)
 Chrysler "LH" Body (Intrepid, Vision, Concorde, LHS)
 Honda Accord, Acura Integra, Mazda 929

Consult the vehicle service manual for details on how to loosen the engine cradle.

The Cradle Adjust screen has a graphic of the cradle with an arrow showing the direction of needed movement. A meter display determines exact placement. In addition, a live caster reading is shown for reference.

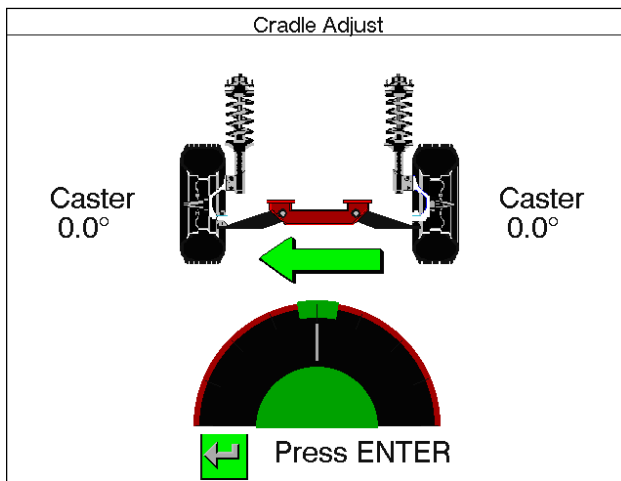

Adjustment Assistant ... continued

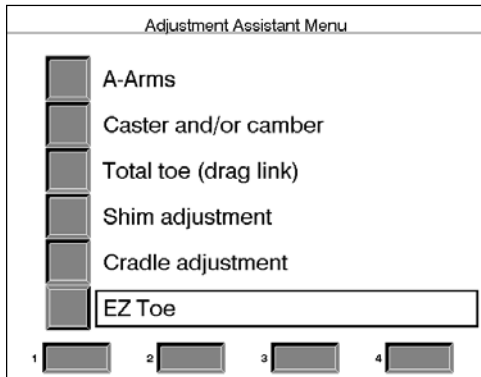

EZ Toe -- The EZ Toe software routine is a new and improved method of setting front toe. The program *calculates the amount of toe change needed on each wheel*. When toe is corrected on either wheel, the program only remembers the amount of change needed for that wheel (similar to the Elevated Camber adjustment function), ignoring the current position of the wheel or the reaction of the opposite wheel. This allows accurate toe adjustment with the wheels pointed in any direction (within the range of toe signals) without the use of a steering wheel holder. It is even possible to correct toe with the wheels turned to 10 degrees left or right, which is helpful on cars with firewall-mounted center-point rack and pinion steering linkages. Because of the toe-change method, EZ Toe minimizes comebacks due to crooked steering wheels.

EZ Toe Procedure

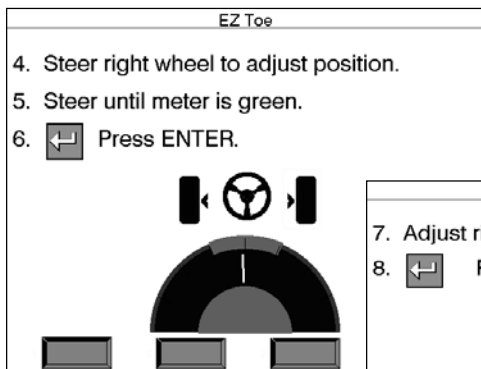

1. Perform all alignment steps normally used to obtain alignment readings. Correct any misalignment in the rear as well as front caster and/or camber.

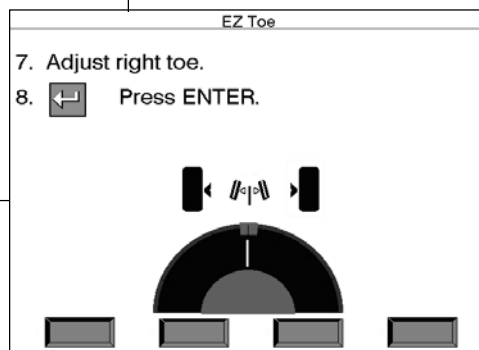

2. Select EZ Toe from the Adjustment Assistance Menu. *Note: DO NOT use the Steering Wheel Clamp during the EZ Toe procedure.*

3. Level the vehicle steering wheel and the measuring heads. Press Enter.

4. Steer the right wheel to adjust the position until the meter is in the green. Press Enter.

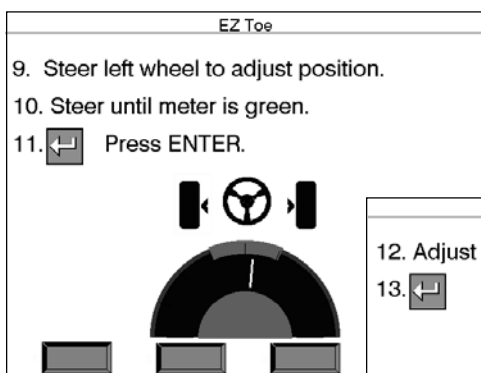

5. The next screen shows a meter indicating the amount of toe change needed for the right wheel.

6. Adjust the right tie rod until the meter needle is in the green. Press Enter after completion.

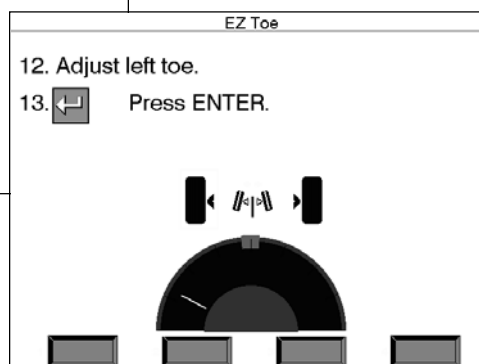

7. Follow the same procedures for the left wheel.

8. Press Enter once the left toe adjustment is made.

9. Return to the Front Readings screen and recheck toe and steering wheel position.

Other Soft-Key Features

Driver Complaints Menu -- this menu is accessed by toggling to the second set of soft-keys on either the front or rear readings screens and pressing soft-key#4. It contains a series of screens designed to assist the technician with diagnosing specific drivability concerns. With the exception of "Advanced diagnostic", a series of questions about the vehicle's problems or symptoms is presented. As the technician follows the steps, suggestions are made on probable causes. The following selections are available:

- Advanced diagnostics**
- Pull**
- Unlevel steering**
- Vibration**
- Treadwear**

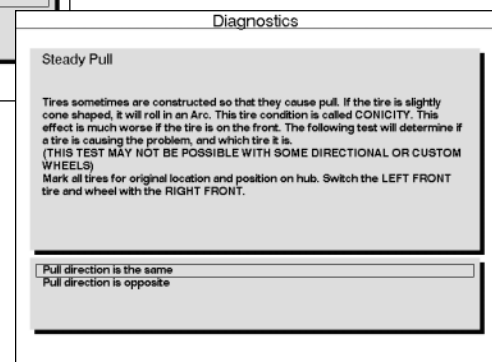
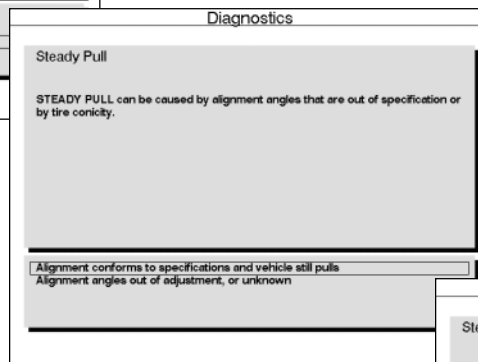
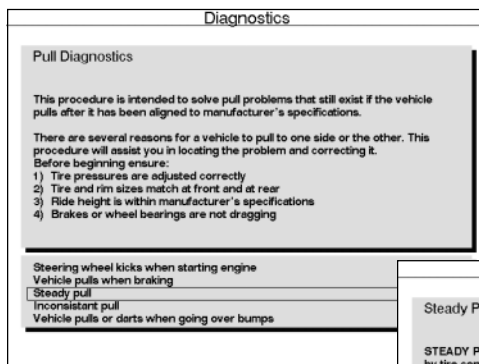
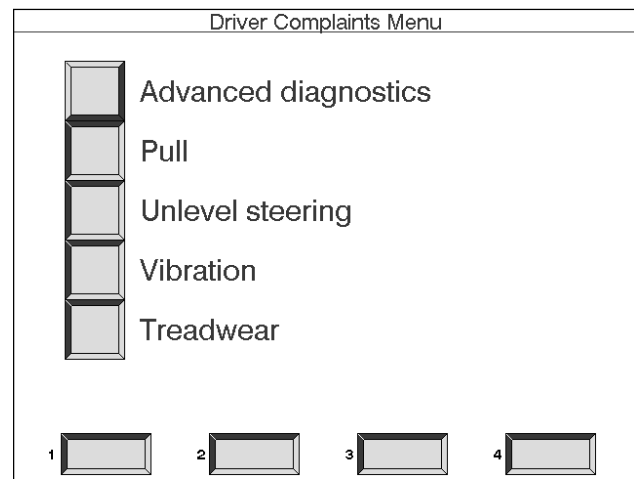

Advanced diagnostics -- this choice brings up a routine that compares the measured angle readings to specification. If out of specification, the program will identify probable results due to misalignment and, if SAI and Included Angle have been measured, may identify possible bent parts. See page 52 for additional details.

Pull -- the program will ask a series of questions regarding the vehicle pull. Select the most appropriate answer to move to the next test. The screen will again ask for the most correct answer. Suggestions will be made throughout the test to attempt to identify the problem.

Other Soft-Key Features

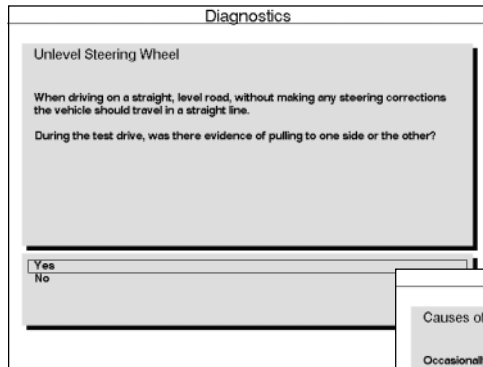

Unlevel Steering -- the program will ask a series of questions regarding the unlevel steering wheel. Select the most appropriate answer to move to the next test. The screen will again ask for the most correct answer. Suggestions will be made throughout the test to attempt to identify the problem.

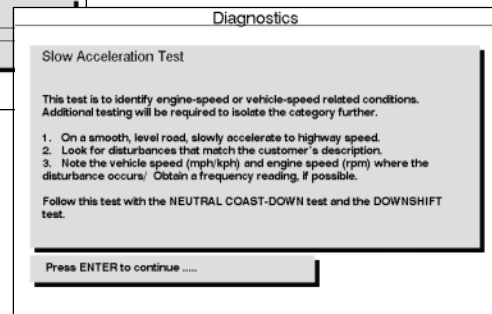
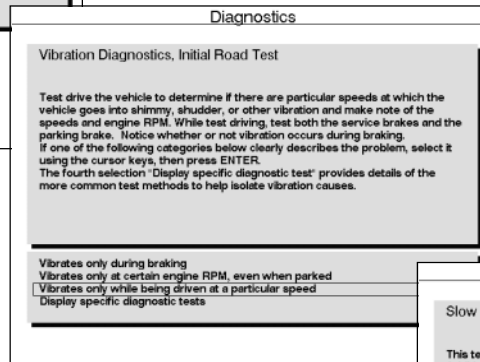
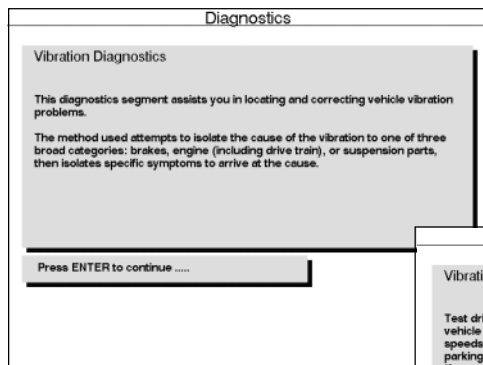
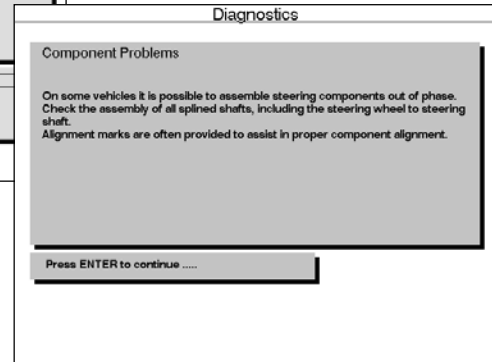
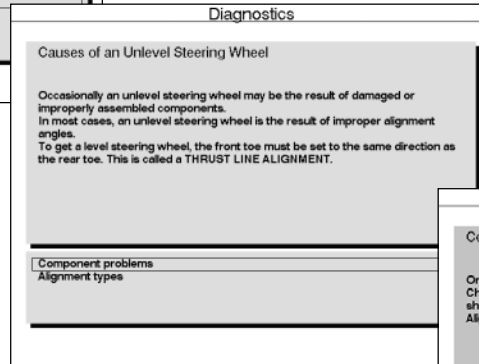

Vibration diagnostics

This diagnostic segment assists in locating and correcting vehicle vibration problems. The method used attempts to isolate the cause of the vibration to one of three broad categories: Brakes, Engine and Drive Train.

Other Soft-Key Features

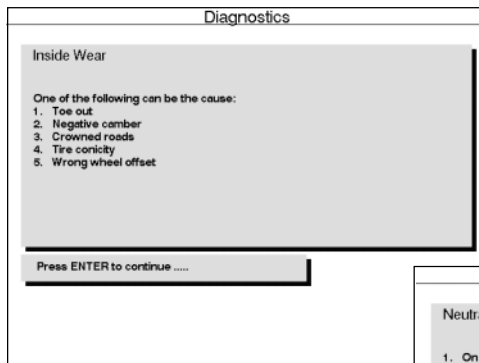

Treadwear -- there are many reasons that tires wear unevenly and wear out prematurely. Because the effects of having more than one problem can make it difficult to exactly pinpoint the problem, this guide will lead you through lists of possible causes. Use the up and down arrow keys and the "Enter" key to select the most applicable categories or answers.

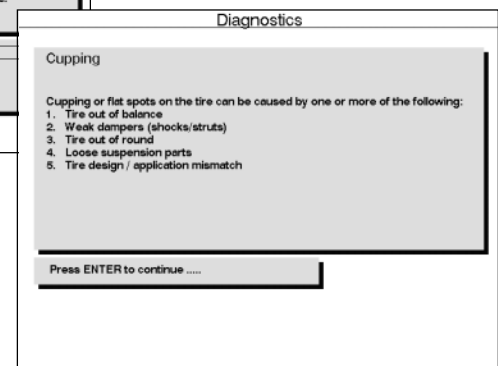
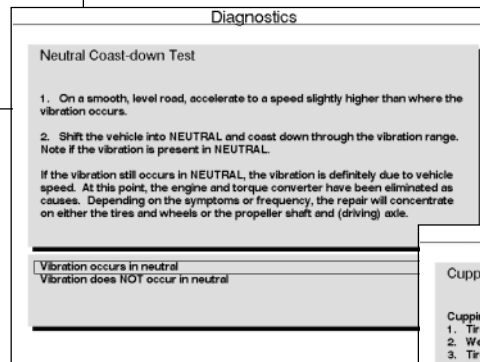

Printer Menu -- use toggle soft-key #1 "Print" on either the Front or Rear readings display to go to the Printer Menu. The options are:

Print alignment results -- prints only measured alignment angles with specifications

Print results (no specs) -- prints all measured alignment angles without specifications

Print inspection list -- prints only inspection lists that have been filled out - no alignment angle results

Print all -- prints everything - alignment angles, specifications, inspection reports

Save current alignment -- usable only with optional Customer Database feature. Saving the alignment from this menu saves all alignment information to a computer disk. For more details, see section 5, Files.

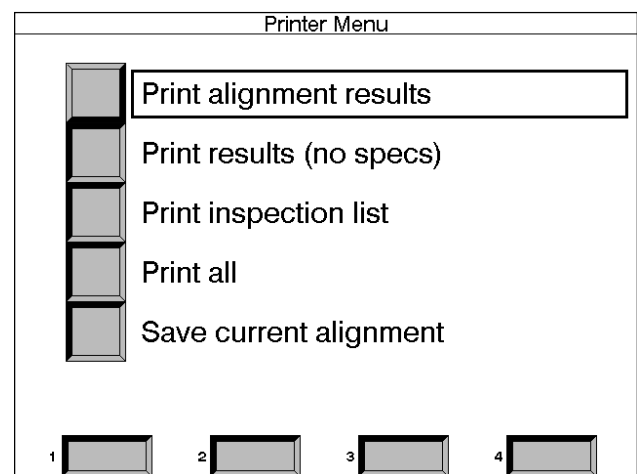

This completes the instructions on how to use the Visualiner software to perform a wheel alignment and diagnose alignment related drivability problems. Keep this manual readily available as a reference when questions are encountered. For additional assistance, contact the local John Bean Company Representative, or contact one of the John Bean Company locations worldwide using the information on the back page of this manual.

Glossary of Alignment Terms

- * Ackerman Principle: An alignment principle based on vehicle tread width and wheelbase upon which turning angle is computed.
- * Active Suspension: A suspension system in which hydraulic actuators add force to the suspension system to allow compression (Jounce) and extension (Rebound).
- * Alignment: The process of measuring and positioning all wheels attached to a common chassis.
- * Angle: Two intersecting lines that are not parallel.
- * Arc: Any part of a circle or a curved line.
- * Axial Play: Vertical movement of the wheel and tire assembly when inspecting a ball-joint.
- * Balance: This term is used to describe having equal weight distribution about the circumference of a wheel and tire assembly.
- * Ball-Joint.: A chassis to knuckle connector consisting of a ball and a socket. This configuration allows for simultaneous angular and rotating motion.
- * Bead: Steel wire forming an anchor for individual plies and rim attachment of a tire.
- * Bellows: a Rubber type seal which is folded to allow for a telescopic action. Normally referred to as a bellows boot.
- * Bias Belted: A tire construction type with overlapping plies at 90 degrees with additional belts formed around the circumference of the tire.
- * Bias Ply: The same type of construction is used on this design as a bias belted, but without the reinforcement belt.
- * Body Roll: The leaning of the vehicle body while cornering.
- * Braking Control: Vehicle stability related to the reaction under all stopping conditions.
- * Bump Steer: A directional change in steering caused by road irregularities. As the suspension moves through jounce and rebound, changes in alignment at the front or rear wheels may alter the vehicle's directed path.
- * Bushing: A component made of metal or rubber-type material, used to isolate interconnected moving parts.
- * Cam Bolt: A bolt and eccentric assembly which when rotated will force components to change a position.
- * Camber: The inward or outward tilt of the wheel at the top and as viewed from the front.
- * Camber Roll: A change in camber brought about by suspension changes while cornering.
- * Caster: The forward or rearward tilt of the steering axis at the top and as viewed from the side.
- * Center Bolt: A bolt that provides centering and attachment of an axle and spring assembly.
- * Centerline Steering: A centered steering wheel while the vehicle is traveling in a straight ahead course.
- * Chassis: All major assemblies on a vehicle including suspension, steering, drivetrain and frame; everything except the body.
- * Circumference: The total distance around a circle.
- * Coil Spring: Spring steel wire formed in the shape of a coil.
- * Compliance: The ability of an object to yield elastically when a force is applied.
- * Concentric: Two or more components sharing a common center.
- * Conicity: The cone shape that a tire takes through its normal life when inflated and loaded.
- * Contact Area: The total amount of tread surface that contacts the road.
- * Control Arm: An arm that is used to attach a spindle or axle to the chassis.
- * Cornering: The ease at which the vehicle travels a curved path.
- * Cradle: The framework of a front wheel drive vehicle that provides the engine mounts as well as front suspension pivot points for many vehicles.
- * Curb Weight: The overall weight of a vehicle less passengers, luggage, or load.
- * Degree: A unit of measurement to describe an angle.
- * Dial Indicator: An instrument used to measure and display linear displacement. Measurement is displayed on a dial face and the scale is commonly graduated in thousandths.
- * Directional Stability: The tendency of a vehicle to maintain a directed path.
- * Drag Link: A tube or rod used for interconnection between a pitman arm and tie-rod assemblies.
- * Dry Park Check: Inspection of chassis and steering parts with the vehicle at normal ride height. Not in the raised position.
- * Dynamic Balance: This normally refers to the balance condition of a wheel and tire assembly in motion.
- * Eccentric: See cam bolt.
- * Feather Edge Wear Pattern: An abnormal tread wear pattern whereby one side of an individual tread rib is worn more than the other.
- * Flow Control Valve: Regulates flow output from the power steering pump. This valve is necessary because of the variations in engine RPM and a need for consistent steering ability in all ranges from idle to highway speeds.
- * Foot Pound: A unit of measurement used to describe torque force.
- * Four Wheel Steering: The ability of the rear wheels to aid in steering a vehicle for improved handling and driving characteristics.
- * Frame Angle: Used to describe a non-level frame.
- * Friction Ball Joint: Outer suspension pivot that does not support the weight of the vehicle.
- * Front Steer Rack and Pinion: Steering system located in front of spindle centerline.
- * Geometric Centerline: A line drawn between the midpoint of the front axle and the midpoint of the rear axle.
- * Horizontal: Parallel or level with the plane of the horizon.
- * Hub: The assembly that houses the bearings about which the wheel and tire assembly rotates.
- * Hydraulic Pump: A power driven device generating constant volume and pressure.
- * Idler Arm: An arm and lever assembly used to support and maintain a parallel position with a conventional steering system.
- * Included Angle: The sum of the angles camber and SAI.
- * Independent Suspension: A suspension system that provides an isolated mounting for each wheel to the chassis.

Glossary of Alignment Terms

- * Individual Toe: The angle formed by a horizontal line drawn through the plane of one wheel versus a centerline.
- * Integral Power Assist: A power assist system where the control valve and all major hydraulic components are self-contained.
- * Intersect: The crossing point of two lines.
- * Jounce Travel: A suspension moving up through its travel.
- * Kinetic Balance: The balance condition of a rotating wheel related to force generated in a vertical plane.
- * King-Pin: A pin used to attach a spindle to an axle.
- * Lateral Run-Out: Side-to-side movement with a rotating wheel or tire.
- * Lead: A slight tendency for a vehicle to lead away from its directed course.
- * Linkage: A series of rods or levers used to transmit motion or force.
- * Load Carrying Ball Joint: Outer suspension pivot that supports the weight of the vehicle.
- * Load Range: A system used to describe the service or weight limitations of a tire.
- * MacPherson Strut: A suspension design where spindle, shock, and spring are all one assembly.
- * Memory Steer: A condition where the wheels, rather than returning to straight ahead, tend to remember and seek a previous position.
- * Millimeter: A unit of linear measurement. One millimeter is equivalent to 0.039 inches.
- * Minute: A unit of measurement used to describe an angle. One minute is equivalent to 1/60th of one degree.
- * Non-Integral Power Assist: A power assist system where the control valve and all major hydraulic components are not self-contained.
- * Offset: The lateral displacement of a wheel or axle in respect to a centerline.
- * Oscillate: A motion in two directions and at a specific frequency.
- * Out-of-Round: A wheel and tire irregularity in which one or both are not concentric with its axis of rotation.
- * Overinflation: Inflation pressure beyond what is recommended.
- * Oversteer: A characteristic in which a vehicle has a tendency to turn sharper than the driver intends.
- * Parallelogram Steering Linkage: A steering linkage design where if all pivot points are connected by lines, these lines would be parallel.
- * Passive Suspension: A suspension system which uses springs along with shock absorbers to allow compression (Jounce) and extension (Rebound).
- * Perpendicular: Being at right angles.
- * Pitman Arm: A steering component that provides interconnection between the steering gear sector shaft and the steering linkage.
- * Ply Rating: A method of rating tire strength; not necessarily indicative of the actual number of plies used.
- * Power steering: A steering system which incorporates hydraulics to assist in the steering of the wheels.
- * Pre-load: A predetermined amount of load or force applied during assembly to prevent unwanted play during actual operation.
- * Pressure Relief Valve: Prevents power steering fluid pressure buildup beyond a specified point. When fluid is at the maximum desired pressure the excess is returned to the pump reservoir.
- * Pull: The tendency for a vehicle to steer away from its directed course.
- * Rack and Pinion Steering Gear: A steering system design that utilizes a pinion gear meshed with a rack gear to transmit steering forces to the spindles.
- * Radial Play: Any lateral movement of the wheel and tire assembly when inspecting a ball-joint or king-pin.
- * Radial Ply Tire: A tire construction type with alternating plies 90 degrees to the tire bead.
- * Radius: The distance from the center to the outer edge of a circle.
- * Rag Joint: A type of U joint constructed from a rubberized fabric type material.
- * Rear Steer Rack and Pinion: Steering system located in front of spindle centerline.
- * Rebound: A suspension moving down through its travel.
- * Recirculating Ball Steering Gear: A steering gear design that is made up of a worm shaft, ball nut, and two recirculating ball circuits.
- * Returnability: The tendency of the front wheels to return back to a straight ahead position.
- * Road Crown: The slope of a road from its center.
- * Road Feel: Necessary feedback transmitted from the road surface up to the steering wheel.
- * Road Isolation: The ability of a vehicle to better separate road irregularities from the driver and passengers.
- * Road Shock: An excessive amount of force transmitted from the road surface up to the steering wheel.
- * Scrub Radius: The radius formed between wheel centerline and steering axis projected load points at the road surface.
- * Setback: The angle formed between a centerline and a line perpendicular to the front axle.
- * Shim: Thin material of fiber or metallic makeup used to take up clearance between two parts.
- * Shimmy: A violent shake or oscillation of the front wheels transmitted up to the steering wheel.
- * Shock Absorber: A suspension component used to dampen spring oscillation.
- * Solid Axle Suspension: A suspension system consisting of one steel or aluminum I-beam extended the width of the vehicle.
- * Short Arm Long Arm (SALA): An independent suspension design incorporating unequal length control arm.
- * Spindle: A component on which a wheel and tire assembly is mounted and rotates.
- * Stability: The tendency of a vehicle to maintain a directed course.
- * Stabilizer Bar: A steel bar used to minimize body roll.
- * Steering Arms: A steering component which provides interconnection between the outer tie-rod and spindle.
- * Steering Axis Inclination: The angle formed by an imaginary line drawn through the steering axis versus vertical. Viewed from the front.

Glossary of Alignment Terms

- * Steering Gear: A mechanical device used to convert the rotary motion at the steering wheel to a lateral motion.
 - * Steering Geometry: See Alignment.
 - * Steering Knuckle: A forged assembly which typically includes: the spindle, steering arm and steering axis pivot points.
 - * Steering Shaft: A tube or rod which interconnects the steering wheel to the steering gear.
 - * Steering Wheel Play: Any abnormal play or movement that does not result in movement at the front wheels.
 - * Strut: Any support used between two parts.
 - * Suspension: An assembly used to support weight, absorb and dampen shock, help maintain tire contact, and proper wheel to chassis relationship.
 - * Suspension Height (Ride Height): The specified distance between one or more points on a vehicle to the road surface.
 - * Thrust Angle: The angle formed by thrustline and geometric centerline.
 - * Thrustline: Average rear toe added together and divided by two. The direction the rear rolls.
 - * Tie Rod Assembly: The outer most assemblies on a parallelogram steering linkage. These assemblies are attached to the drag link and steering arms.
 - * Tie Rod End: The ball and socket assembly of a tie rod.
 - * Tie Rod Sleeve: A threaded tube that provides connection and adjustment of a tie rod assembly.
 - * Tire Force Variation (Radial Force Variation): A tire irregularity in which there is a difference in radial stiffness about the circumference of the tire.
 - * Tire Wear Pattern: The design developed on the tread surface from abnormal wear.
 - * Toe: The comparison of a horizontal line drawn through both wheels of the same axle.
 - * Turning Angle: The difference in the turning angle of the front wheels in a turn.
 - * Torsion Bar: A spring steel bar used in place of a coil spring. Suspension is provided through its resistance to a twisting or torque effort.
 - * Torque Steer: The effect that acceleration or deceleration has on the steering of the front wheels.
 - * Tracking: The interrelated paths taken by the front and rear wheels.
 - * Treadwidth: The dimension as measured between the centerlines of the wheels on the same axle.
 - * Treadwear Indicators: Ridges molded between the ribs of the tread that visibly indicate a worn tire.
 - * Underinflation: Air pressure below that which is specified.
 - * Understeer: A characteristic in which a vehicle has a tendency to turn less than the driver intends.
 - * Unit Body (Uni-Body): A design that incorporates both body and frame as a unit.
 - * Vertical: Being exactly upright or plumb.
 - * Vibration: To constantly oscillate at a specific frequency.
 - * Waddle: The lateral movement of a vehicle usually caused by some type of tire or wheel imperfection.
 - * Wander: The tendency of a vehicle to drift to either side of its directed course.
- * Wheel Base: The dimension as measured between the center of the front and rear axles.

(Blank Page)



Visualiner Series

Files Menu and Customer Database

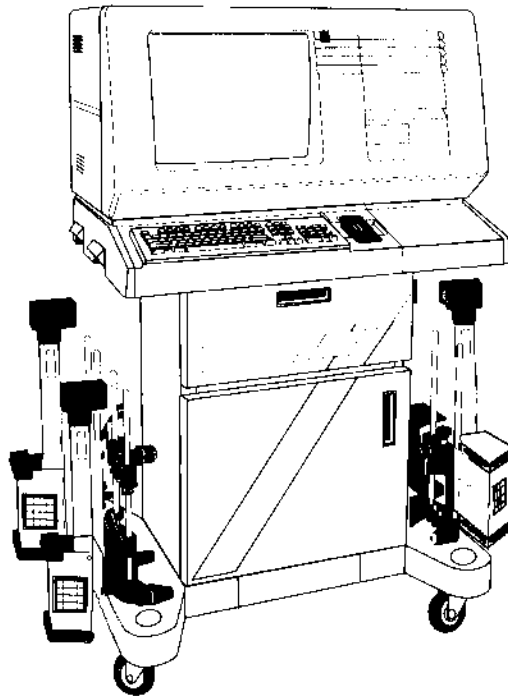

(Blank Page)

Files Menu

The Files selection of the Main Menu allows access to the Customer Database option and other Visualiner functions. Place the highlight box around Files and press Enter.



Files Menu -- from the Files Menu choices are:

Customer files -- accesses Customer Database functions such as view or print records and selection of storage drives

Special vehicle specifications -- allows the setup of external specification databases

Store name -- enter the store information to be included on all printouts

Demo program -- for John Bean Company personnel only

Mitchell -- allows access to Mitchell On-Demand (optional), a CD-ROM based auto repair shop manual system

EZ Shim -- accesses a program designed by Specialty Products Co. to determine the proper installation of their EZ Shim product

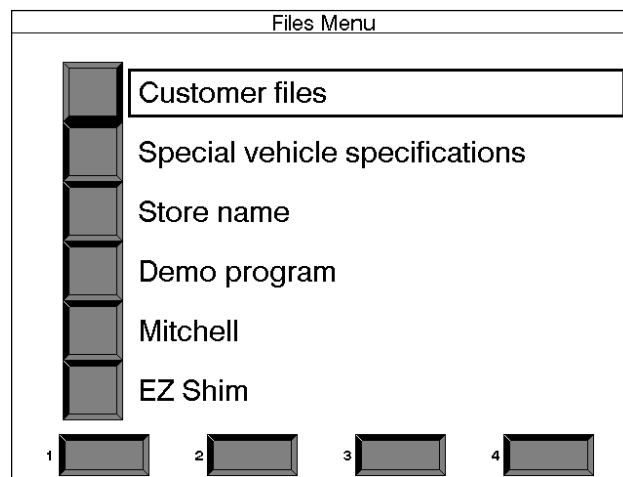

Customer Database

Customer Database is a Visualiner feature (standard on some models, not available on some, optional on others) that allows the aligner user to permanently store information about the customer, his vehicle, and the results of the wheel alignment service. A "database" is a collection of information to be sorted and retrieved as needed for analysis. Available information includes the car owner's last name, address, phone number; the vehicle make/model/year, VIN number, and mileage; plus the date of service along with before and after alignment readings. This information is stored on a computer disk drive for later retrieval. Once retrieved, the information can be reviewed and can become the starting point for a new alignment.

Prior to saving the alignments, it is necessary to setup the system and learn the steps to store and retrieve data during an alignment.

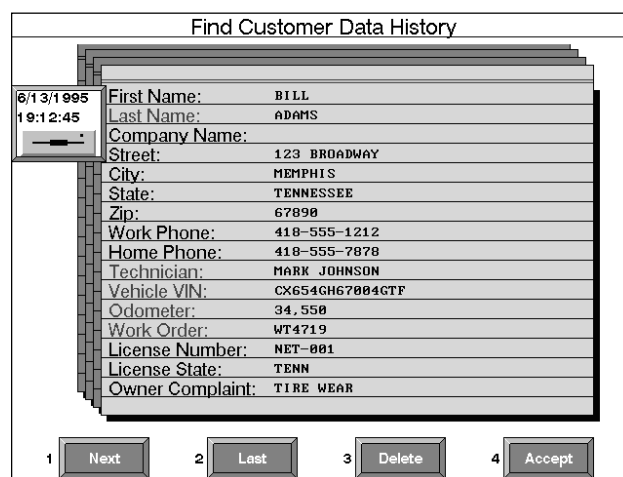

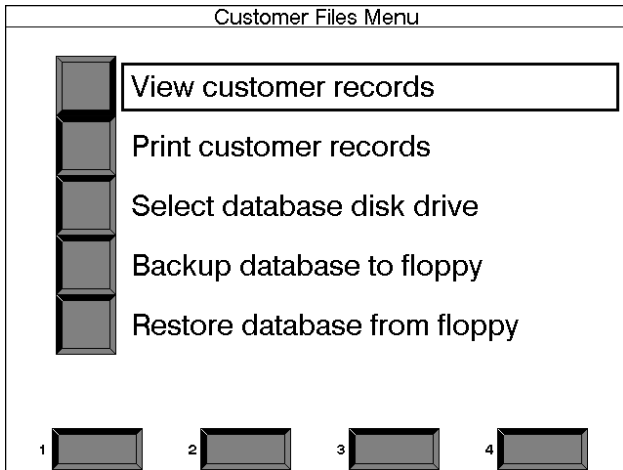

Customer Files Menu

From the Files Menu, select "Customer Files". Choices are:

View customer records -- allows sorting and viewing of customer database records

Print customer records -- this selection causes a memory dump of all records sorted by last name to the printer. Only name and address are sent to the printer.

Select database disk drive -- specifies the drive in the computer where customer records will be stored

Backup database to floppy -- if records are stored on the computer's hard drive, this allows a backup to be done as a data security measure

Restore database from floppy -- any backup data from a floppy disk can be placed onto the hard drive

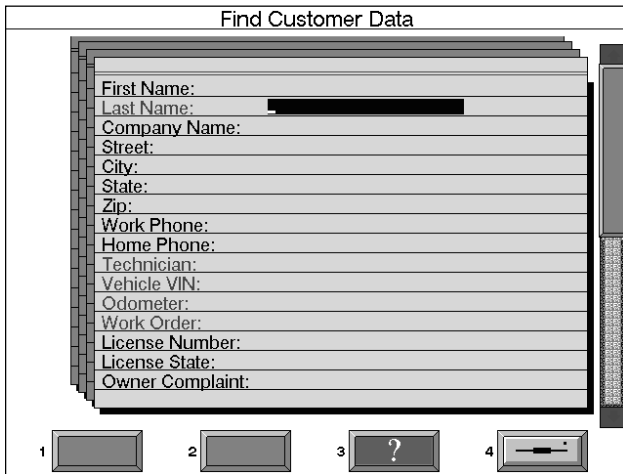

Select "View Customer Records" from the customer files menu. A blank data sheet will appear. Move the selector up or down the screen using the arrow keys to sort on a variety of topics. A search could be on last name, phone number, or license plate number. At the desired topic, type in the information to search for. Press Enter and the computer will sort by that data field and bring up any available records. Pressing the soft-key #1 "Next" goes to the next record in the database, pressing soft-key #2 "Last" goes back one record. When viewing customer records under the Files Menu, before and after alignment readings cannot be viewed.



The process described above is also utilized when doing a wheel alignment. When the Customer Data screen appears, press soft-key #1 to open up a blank sheet to search for the desired records. This process is described in detail on page 90.

Selecting the Disk Drive -- to determine which disk drive the computer will refer to when writing or retrieving data, choose "Select database disk drive" from the Customer Files Menu. The selections are A, B, or C. Disk drives A and B are Floppy drives. These are disks which can be interchanged between machines and computers. The "C" drive is a "Hard Disk Drive" permanently mounted inside the computer. The Hard Drive contains much more storage capacity than a floppy disk. Select the appropriate drive letter for the computer configuration of the Visualiner. If in doubt, contact a John Bean Representative.

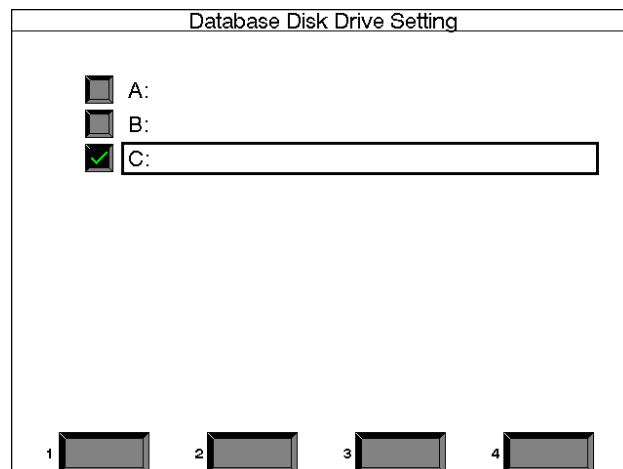

Backup Database -- the computer system will allow the customer data to be stored onto a floppy disk drive for safe keeping or for use at another location. Information which has been backed-up onto the floppy can be reentered back into the computer. To backup the database simply select "Backup database to Floppy" from the Customer Files Menu. The computer will then ask you to insert a floppy disk into the drive slot and press Enter. The computer now takes over and copies all the internal files to the floppy for storage. After backup, the computer will ask if the internal file is to be erased to make room for more data. If "Yes" is selected all internal data will be erased! Selecting "No" will allow more data to be added.

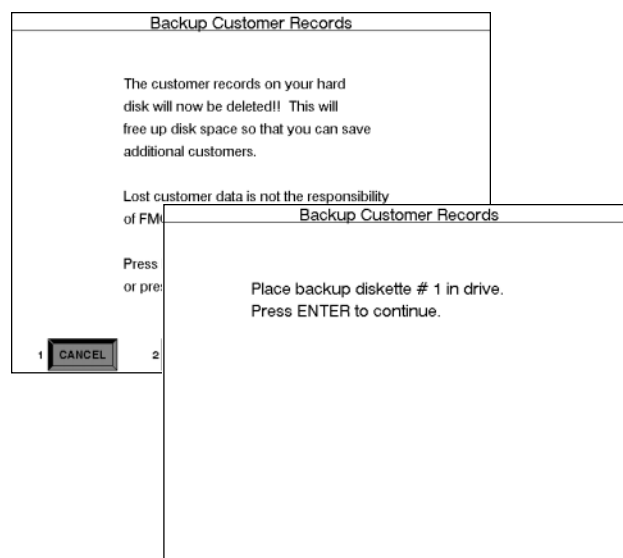

NOTE: Any existing customer files on the floppy will be overwritten. If additional diskettes are required, contact your John Bean Company representative or request a pre-formatted 3.5" 1.44 MB diskette from a local computer supplier.

Data Retrieval, Restore -- if data is to be restored to the internal hard drive, select "Restore from Floppy" at the Customer Files Menu. The screen asks you to insert the floppy which contains the desired information into the floppy disk drive slot and press enter. The stored information is then read into the computer for use. Please note that when the data is read into the computer the existing file will be overwritten. Make sure that the data on the disk is that which is desired on the computer.



Customer Menu

New customer

Find customer data

Continue previous alignment

1 2 3 4

Customer Data

Find Customer Data

1 Find 2 3 ? 4

Find Customer Data History

6/13/1995
19:12:45

First Name: BILL
Last Name: ADAMS
Company Name:
Street: 123 BROADWAY
City: MEMPHIS
State: TENNESSEE
Zip: 67890
Work Phone: 418-555-1212
Home Phone: 418-555-7878
Technician: MARK JOHNSON
Vehicle VIN: CX654GH67004GTF
Odometer: 34, 550
Work Order: WT4719
License Number: NET-001
License State: TENN
Owner Complaint: TIRE WEAR

1 Next 2 Last 3 Delete 4 Accept

Using Database During an Alignment

After choosing Begin Alignment the Customer Menu will appear. If the Visualiner is equipped with the Customer Database feature, select "New customer" to add a new record. To find an existing record select "Find customer data". If the Visualiner does not have the database option, a message stating "This Feature not Activated" will appear.

Adding a New Customer Record -- when "New customer" is selected, a blank Customer Data page will appear. Using the keyboard, type in all pertinent information about the customer and his vehicle in the fields provided. Once completed, there are two options: soft-key #3 "Save" will save only the customer information that is on the screen or, if inspection and alignment data is desired to be saved, press soft-key #4 to continue. The opportunity to save all information will come at the completion of all alignment procedures.

Finding a Customer Record -- when "Find customer data" is selected (or soft-key #1 on the Customer Data screen), a blank data screen appears with a dark box (white cursor in it) in the First Name field. This box is the search criteria selector. Using the up/down arrow keys, choose the desired field to search for the customer record (i.e. last name, plate #, etc.). In the field, type the customer information and press Enter. Any information in the Visualiner database that corresponds to the search criteria will appear. If there is more than one record for that criteria (i.e. two people with same last name) press soft-key #1 "Next" or to move backwards in the database press soft-key #2 "Last". Notice the complete customer information including the date of service.

To continue reviewing all information associated with this customer record, press soft-key #4, "Accept".

Vehicle Specification History -- the next screen that appears shows the specifications from the stored alignment. This eliminates the need to reenter specifications, even if they were "Custom" specs. The vehicle adjustments can be illustrated by pressing soft-key #2. Press soft-key #4 to continue.

Vehicle Specifications History			
94 HONDA PRELUDE 2WS			
Front	MIN	PREF	MAX
Caster left	1.7°	2.7°	3.7°
Caster right	1.7°	2.7°	3.7°
Camber left	-1.0°	0.0°	1.0°
Camber right	-1.0°	0.0°	1.0°
Total toe	-0.16°	0.00°	0.16°
SAI		---	
Rear			
Camber left	-1.8°	-0.8°	0.3°
Camber right	-1.8°	-0.8°	0.3°
Total toe	0.00°	0.16°	0.32°

1 2 3 4

Inspection Menu History -- if any vehicle inspections were performed and entered into the Visualiner database they can be recalled from this menu. Highlight the desired area to examine the results. Any items that were checked, serviced, or recommended for replacement during this previous alignment service will be shown. Press soft-key #4 to continue to the alignment readings review.

Inspection Menu History	
	Pre-alignment
	Tires
	Brakes
	Undercarriage
	Undercarriage
	Courtesy

1 2 3 4

Pre-alignment Inspection History	
<input type="checkbox"/>	Tire pressure
<input type="checkbox"/>	Ride height / System
<input type="checkbox"/>	Ball joints
<input type="checkbox"/>	Tie rod ends
<input type="checkbox"/>	Tie rod adjusting sleeve
<input type="checkbox"/>	Idler arm
<input type="checkbox"/>	Pitman arm
<input type="checkbox"/>	Center link
<input type="checkbox"/>	Control arm / Bushings
<input type="checkbox"/>	Strut rod / Bushings
<input type="checkbox"/>	Stabilizer bushings

All Readings History -- this screen allows a review of the alignment readings as stored in the data record. Only the "All Readings" screen can be viewed (no meter displays). To view the initial alignment readings, press soft-key #2 "Initial" and press soft-key #3 "Final" to see the ending results. The displayed values will be green or red indicating their status versus manufacturers specification. Gray readings indicate there was no specification for that angle. This historical review can be printed by pressing soft-key #1 "Print".

All Readings History		Current rack -- A 44	
Front			
Caster	0.0°	0.0°	0.0°
Camber	0.0°	0.0°	0.0°
Toe	0.00°	0.00°	0.00°
Included angle	0.0°		0.0°
SAI	0.0°		0.0°
Toe out on turns	---		---
Max turns	---		---
Setback		---	
Rear			
Camber	0.0°	0.0°	0.0°
Toe	0.00°	0.00°	0.00°
Thrust angle		0.0°	
Setback		---	
Caster			
94 HONDA PRELUDE 2WS			
1		2	3
			4

This completes the review of all information stored in a customer data record. To perform a new alignment using this customer and vehicle information press soft-key #4 "Align". All customer information will be retained to streamline the alignment process.

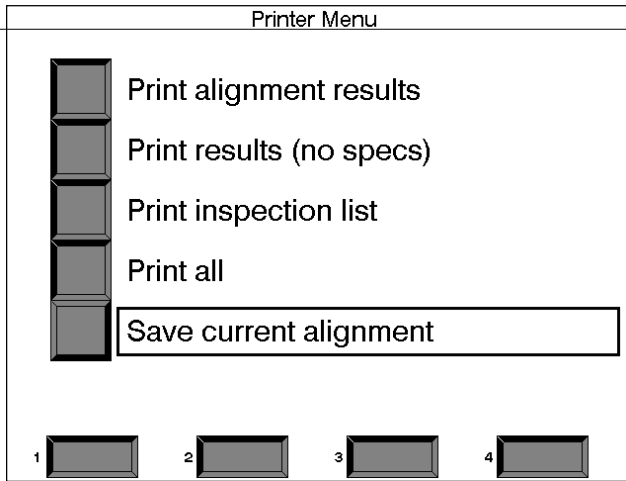

Saving Complete Alignments

As noted on page 90, after entering new customer data, pressing the "Save" softkey will save only the typed information. If all information about the alignment, including inspections and alignment readings, is to be saved, go to the "Print" softkey on either the Front or Rear Readings screen to enter the Printer Menu. The final selection is "Save current alignment". After this is highlighted, press Enter. After approximately 5 seconds a beep will be heard indicating the alignment has been saved. This alignment is now stored in the database for future reference.

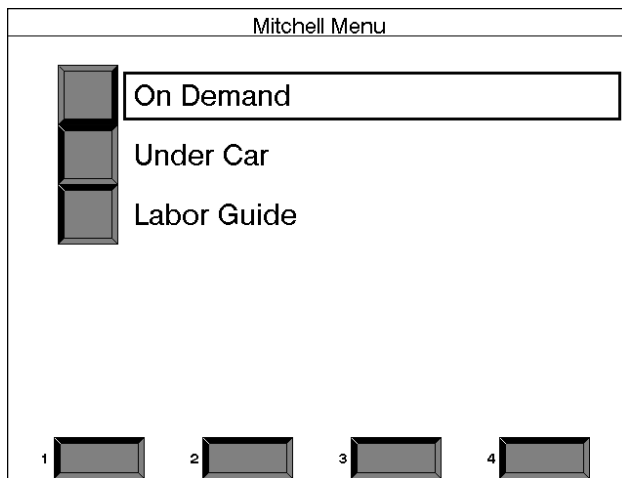
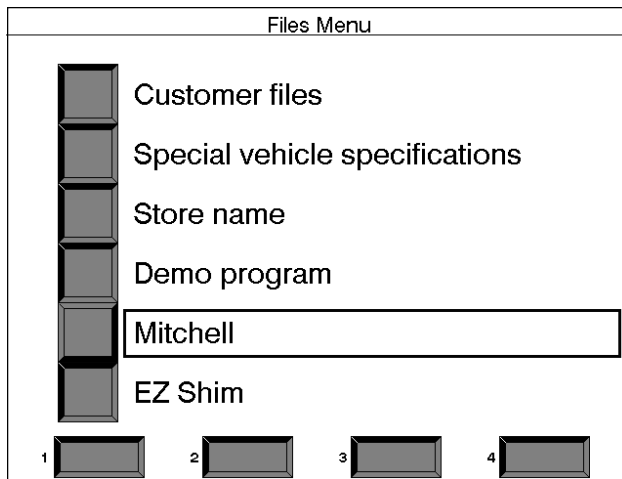

Other Files Menu Selections

Vehicle Specifications -- many businesses now are gathering specific specifications for their fleet contracts or older vintage type vehicles. As the popularity of custom alignments rises, so does the need for retrieval of these specs to avoid needless reentry. The John Bean Visualiner has a spec database option which allows the technician the option of reading specs from a floppy disk. Those specs on floppies can be shared from one unit to another or even from one site to another. The selection of Vehicle Specifications from the Files Menu will enable the aligner to choose the location of externally available disks.

Store Name -- the Store Name selection prompts a screen which allows the user to enter his business name and address to be printed on the results printout.

Demo -- this is a tool used by John Bean Company Sales and Service personnel and is not accessible to the user. It simulates an wheel alignment without using measuring heads and a vehicle.

Mitchell -- John Bean Company USA is a reseller of a product called On-Demand, which is a CD-ROM based shop manual system produced By Mitchell International. If the Visualiner is equipped with Mitchell On-Demand DOS version, it is accessed here. Please note that the DOS version is no longer offered for sale. The Windows version is available, but is not accessed from this menu. Consult with your John Bean Representative about Mitchell product offerings available on various models.

EZ Shim -- this choice is a manual entry spot for the EZ Shim program by Specialty Products Co. When started under the Files Menu it is necessary to manually enter all alignment and specification data. The best place to use the EZ Shim program is during an alignment by choosing the Adjustment Assistant functions (see page 76).

(Blank Page)



Visualiner Series

Maintenance and Service

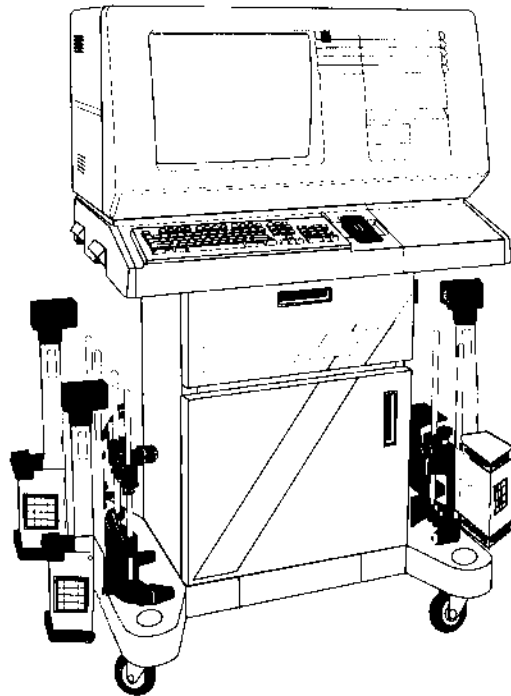

(Blank Page)

Maintaining the Visualiner Series Aligner

Maintenance of the Visualiner is easy and in most cases can be performed by the operator of the machine. A daily cleaning with a mild ammoniated cleaner will maintain the exterior. Using a silicon based spray on the head keypads will keep them soft and pliable giving you years of use. This will help preserve the professional appearance desired in today's automotive shop.

Periodic calibration of the measuring heads insures alignments are done with accuracy and confidence. Using the optional Customer Calibration Kit, John Bean makes basic calibration a simple process allowing the equipment operator to quickly perform the steps whenever necessary. The following pages assist with use of this software and the calibration of the unit. When calibration software is not installed the unit will prompt entry of a "Security Code" for use only by an authorized John Bean Company Service Technician. During the head calibration, if any of the sensors has failed or moved beyond acceptable limits the software will flag the situation and recommend service by a qualified John Bean Company Representative.

In the back of this guide is a troubleshooting guide designed to assist you should a problem occur. Refer to this guide should the unit fail to operate normally.

To access all equipment maintenance functions, use the arrow keys to place the highlight box over "Maintain Aligner" and press Enter.

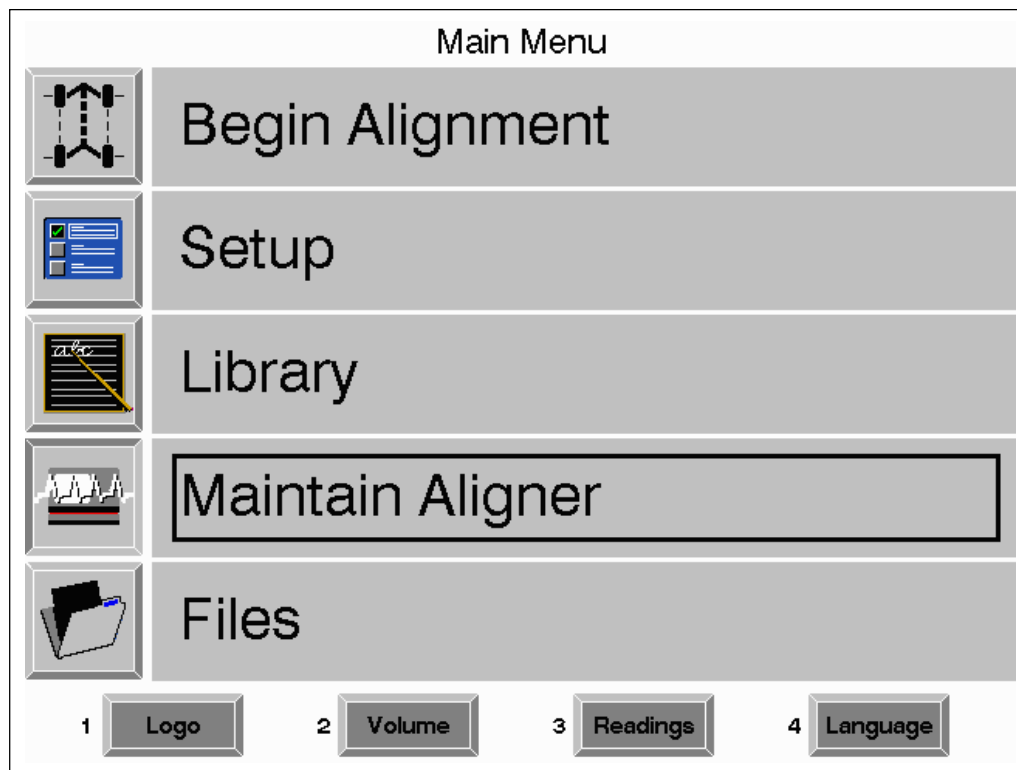

(Blank Page)

Maintain Aligner Menu

This menu is the hub of all Visualiner service and maintenance activities. Choices are:

Calibrate -- the software that enables the measuring heads to be calibrated

Measurement data display -- primarily for John Bean Company service personnel, this allows access to measuring sensor direct output

Aligner diagnostics -- a series of functions for John Bean Company service personnel

Preventative maintenance -- a software feature that guides the equipment operator through recommended periodic aligner maintenance

Alignment Counter -- provides a count of the number of alignments performed by the Visualiner since initial installation and since the last service

Head voltages -- used only on the cordless version of the Visualiner measuring heads

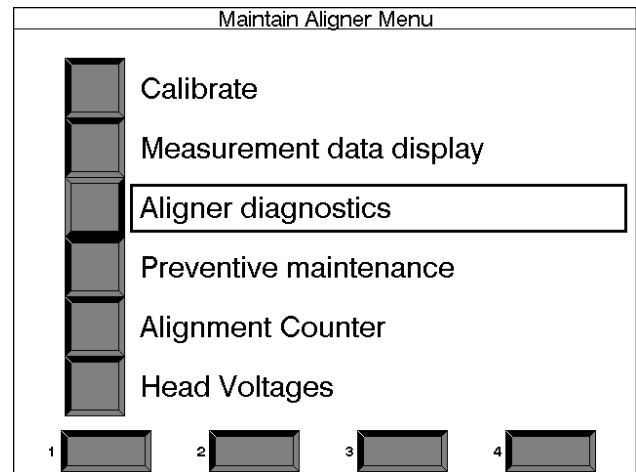

Customer Calibration (with optional kit)

Step 1. Calibrate Aligner -- select this item from the Maintain Aligner Menu and press Enter to access the calibration menus. If the Visualiner is equipped with the optional Preventative Maintenance software, a technician identification screen appears. Any name or ID number can be entered for later verification of the person performing the calibration.



Step 2. Calibration Menu -- select which set of measuring head sensors are to be calibrated. Choices are:

Camber, SAI, and cross toe -- camber sensors are in all heads, while SAI and cross toe sensors are only in the front heads on 6 sensor systems and in the rear heads of 8 sensor systems. Cross toe measures the wheel angles across the front or back of the vehicle

Track toe -- each head has a toe system that measures angles from the front to rear (or vice versa) of the vehicle

Calibration factors -- shows a chart of the current factors that are stored in memory

Clear calibration factors -- resets all factors to zero

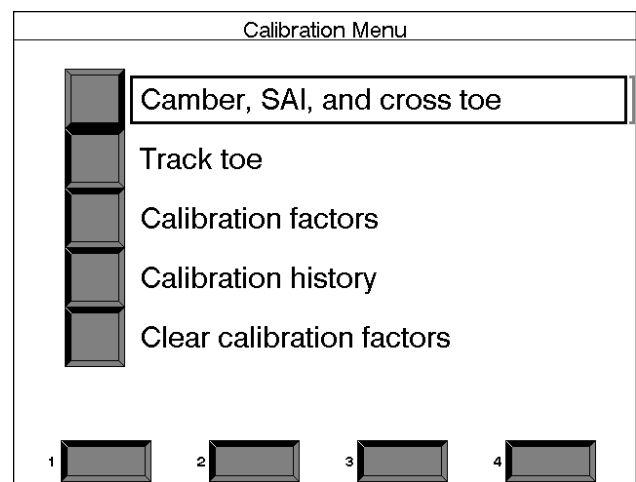

Customer Calibration ... continued

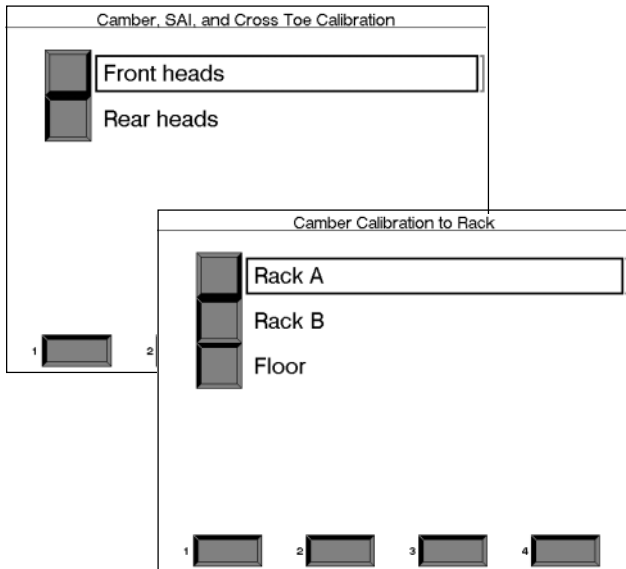

Step 3. Camber, SAI, and Cross Toe Calibration

A. Select whether the front or rear heads are to be calibrated. Press Enter.

B. The screen will prompt to identify which rack is to be calibrated. Up to 3 alignment surfaces can be utilized with the Visualiner Series, and each must be calibrated independently. In most shops, Rack A is the primary alignment surface. Press Enter. Follow all on-screen instructions carefully.

C. The Customer Calibration Kit includes a calibration bar, approximately 6 ft. (2.5m) long and two stands that sit on the alignment rack surface. When performing calibration of the front heads, place the stand on the turntables. When calibrating the rear heads, place the stands on the rear of the rack.

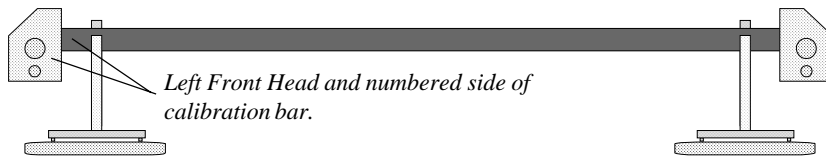
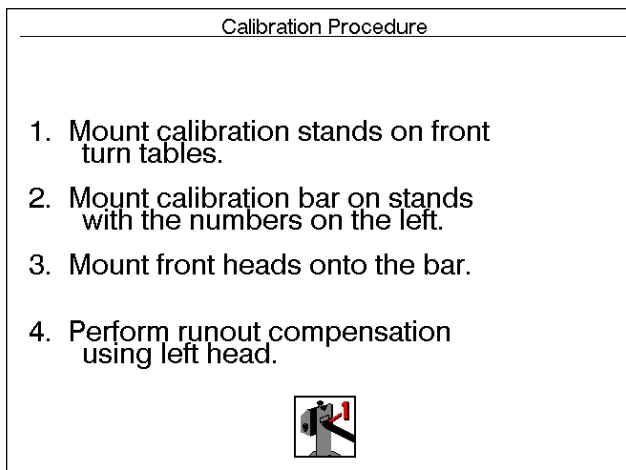

Figure 1. Calibration bar and stands set up on turntables . (Rear View)

The bar is placed in the notches of the stands as shown in *Figure 1*. Make sure the numbered end of the bar (1, 2, 3) is on the left side. Remove the heads from the wheel clamps and mount them on the ends of the calibration bar as shown.



D. The next step is to perform runout compensation of the calibration bar. This is done by rotating the bar until the #1 position is at 12:00, as shown by the flip indicator on the left stand.

At the #1 position, press the "Runout" button on the left head only (*Figure 2*). It is not necessary to take runout on the right head. The light on the runout button will blink. Next rotate the bar until position #2 is at 12:00, and press the runout button on the left head. Repeat for position #3.

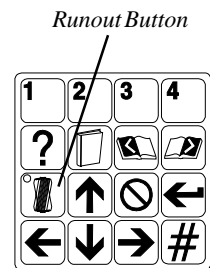

Figure 2. Left Head Keypad

E. After runout is completed the screen will prompt to level and lock the heads. Carefully perform this step using the levels on the heads, then press Enter.

Customer Calibration ... continued

F. Calibration Check / Recalibration -- After completing the runout and level/lock procedure, a screen appears to verify calibration. The screen at the right has three columns. The first column describes the condition of the aligner prior to calibration. The next column is used to display the most recent calibration. The last column shows the total amount of change between calibrations. Should a factor exceed the usable limit, a warning will be displayed which indicates a possible problem and will recommend that a service technician be called. Pressing soft-key #4 "Reject" will cancel the calibration procedure. Pressing #1 "Accept" will use the new calibration factors to perform alignments. Refer to the troubleshooting portion of this guide should the unit fail to work correctly. Use the Calibration Factors Menu to see the results of the calibration. The Visualiner will use these calibration factors to perform alignments. Simply put, this becomes the unit's "0" reference.

Calibration Check / Recalibration			
Sensor	Current Factor	New Factor	Change
LF cross toe	0.02°	-0.03°	-0.05°
RF cross toe	0.04°	0.37°	0.33°
LF camber			
Rack A	-0.33°	-0.86°	-0.53°
RF camber			
Rack A	0.27°	0.53°	0.25°
LF SAI	-0.43°	0.35°	0.78°
RF SAI	0.21°	0.72°	0.51°

Some calibration factors are out of specifications!!
Call a customer service representative to determine the cause of the problem.

1 2 3 4

G. The next screen to appear is "Calibration Notes". The reason the calibration was performed is entered here for future reference. This information becomes a part of the calibration history that is retained by the computer's memory. Select the most logical entry and press Enter.

Calibration Notes

- normal maintenance
- dropped/damaged head
- replaced inclinometer
- replaced LED
- replaced lens
- replaced photoreceiver
- steering wheel not centered
- accelerated tire wear
- vehicle pull
- forced recalibration

1 2 3 4

This completes the calibration procedure for camber, SAI, and cross toe.

Step 4. Track Toe Calibration -- track toe is used to establish the vehicle's rear toe, geometric center line, and thrust line. Track toe calibration must be done on a vehicle using the special Track Toe Fixture that is part of the Customer Calibration Kit. Place all head/clamp assemblies on the vehicle in preparation for these steps. Each head must be done independently. The head to be calibrated must reside on a front wheel with the track toe system facing the rear.

Calibration Menu

- Camber, SAI, and cross toe
- Track toe
- Calibration factors
- Calibration history
- Clear calibration factors

1 2 3 4

A. Select Track Toe from the Calibration Menu. Follow the on screen instructions which assist in the calibration step by step.

Customer Calibration ... continued

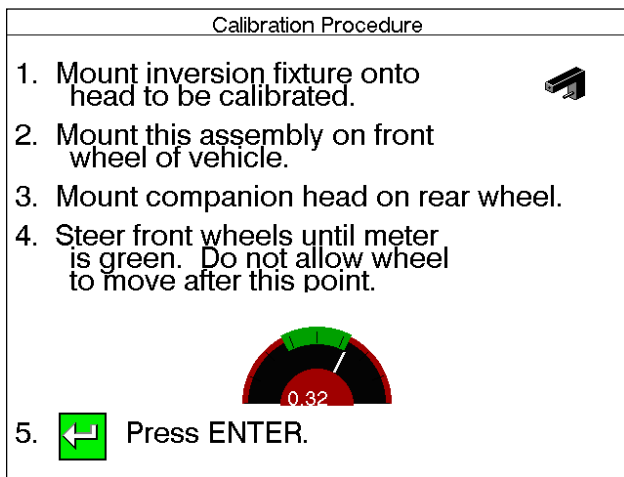
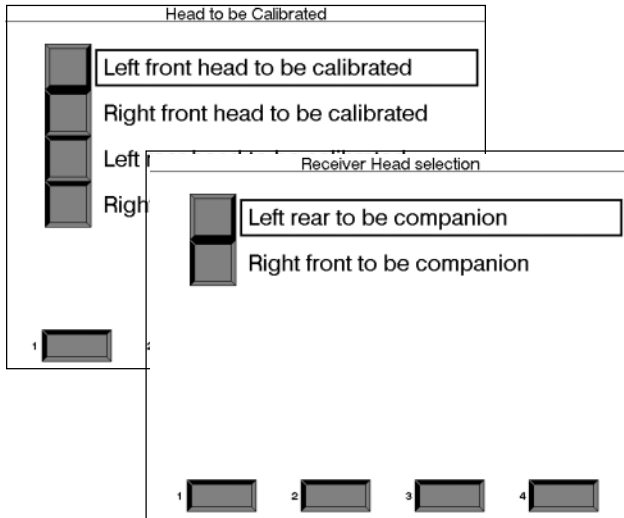

B. Choose the head to be calibrated. The head to be calibrated must be mounted to a front wheel in order to steer when directed.

C. Choose the companion head to be used on the rear wheel to act as a track toe signal receiver.

Track Toe Fixture Setup -- this fixture is included with the Customer Calibration Kit. The kit includes the Track Toe Fixture (L-shaped aluminum piece with a stub shaft), 2 standard head locking knobs, and one locking knob with a longer threaded section. The two standard locking knobs are placed in the threaded holes on the top, in both ends of the fixture. Remove the head to be calibrated from the wheel clamp. Mount the track toe fixture onto the wheel clamp shaft with the larger end facing the wheel. Use the included knob to snug the fixture to the clamp shaft.

D. Remove the tightening knob from the head to be calibrated and place the head on the shaft of the Track Toe Fixture. Using the long screw locking knob going down through the top of the fixture, tighten the head onto the fixture.

E. Mount the companion head on the rear wheel opposite the head being calibrated. Make sure there is a clear line of sight from the front to the rear. Level and lock the companion head.

F. Following the on-screen instructions, steer the front wheel until the reading shown is close to zero.

IMPORTANT NOTE: DO NOT move the wheel at all after this point! DO NOT remove the head from the fixture!

G. The software will prompt to remount the head and Track Toe Fixture upside down. This is done by loosening the knob holding the fixture to the wheel clamp and sliding the fixture off away from the wheel, while being careful not to move the vehicle wheel. Turn the fixture with the head still securely mounted upside down (180 deg.) until the narrow end of the fixture is facing the wheel. Remount this narrow end on the clamp shaft and tighten down the knob/screw. A correct orientation at this point will have the track toe system of the head pointing to the rear. Make sure there is a numerical reading on screen at this point. It may be necessary to point the fixture/head downwards slightly towards the companion receiver head.

Customer Calibration ... continued

H. Once these steps are done, press Enter to view the Calibration Check / Recalibration screen to decide whether to accept or reject the calibration of this head. If the New Factor or Change values are excessive, a warning message will appear. In most cases the calibration factors are good and it is proper to press soft-key 1, "Accept".

I. The Calibration Notes screen will appear to allow entry and storage of the reason for calibration.

J. Repeat these steps for all heads in the system. The Left Front and Right Rear heads are calibrated on the vehicle's left front wheel. The Right Front and Left Rear heads are calibrated on the vehicle's right front wheel. This completes the customer calibration procedure.

Calibration Factors

The calibration factors can be viewed at any time by selecting "Calibration factors" from the Calibration Menu. These factors are referenced each time an alignment is performed. Notice there are three sets of camber factors for the three alignment surfaces.

Calibration Check / Recalibration			
Sensor	Current Factor	New Factor	Change
Left Front Track Toe	-0.06°	0.06°	0.12°

1 Accept	2	3	4 Reject
----------	---	---	----------

Calibration Factors				
06/14/95				
Sensor	LF	RF	LR	RR
Cross toe	0.00°	0.00°		
Track toe	0.00°	0.00°	0.00°	0.00°
Camber				
Rack A:	0.00°	0.00°	0.00°	0.00°
Rack B:	0.00°	0.00°	0.00°	0.00°
Floor:	0.00°	0.00°	0.00°	0.00°
SAI:	0.00°	0.00°		

Calibration History Menu

The past 10 calibrations of the Visualiner can be viewed by selecting "Calibration history" from the Calibration Menu. It gives a graphical presentation of the calibration factors along with dates the calibrations were performed. Reason for calibration detail is accessed by highlighting a date and pressing Enter.

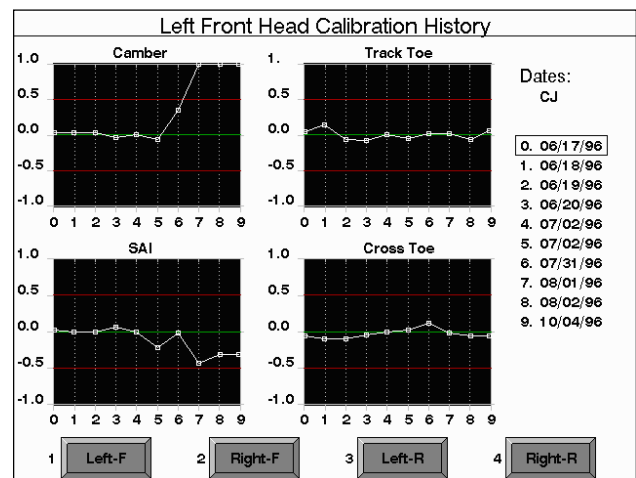

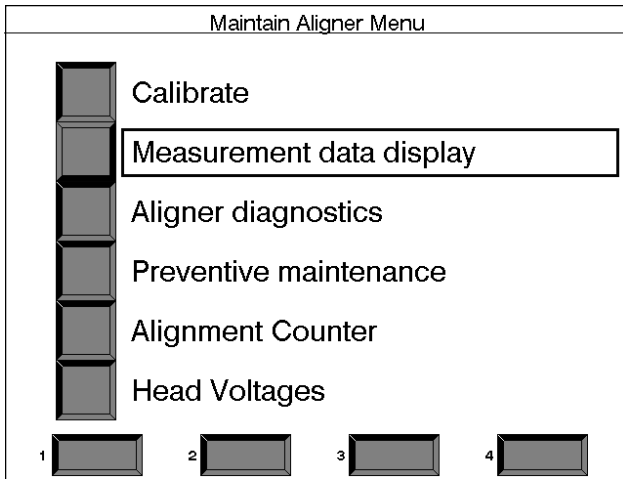

Measurement Data Display

These screens are primarily used by John Bean Service personnel in diagnosing equipment problems. This information displays the direct output of the various measurement sensors used to determine the wheel alignment angles. As the operator of the equipment, it may be useful to have some knowledge of the Visualiner's built-in diagnostic capabilities.

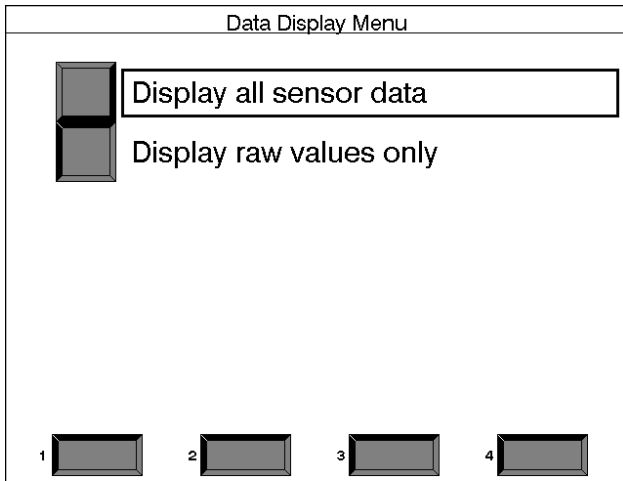

Data Display Menu

There are two screens to view sensor outputs:

- Display all sensor data** -- shows a myriad of system information for advanced diagnostic capabilities
- Display raw values only** -- a simple display of direct output values from the measurement sensors

Display All Sensor Data

The information available on this screen includes:

- Displayed values** -- the alignment angle numbers that are displayed on the Front/Rear Meter screens. Calibration and runout factors are included
- Raw values** -- direct sensor outputs
- Gain** -- amplifier values for toe system circuits

Runout factors -- these values were stored when runout compensation was performed on each wheel. There is a camber and toe plane value given

Calibration factors -- these are the values stored in memory from the last head calibration performed

Head communication -- a status indicator of whether the head computer is communicating with the main computer in the console

Data input -- as a key on the main keyboard or any head keypad is pressed it will appear here.

	LF	RF	LR	RR
Displayed CASTER				
Displayed CAMBER	0.00	0.30	-1.10	1.00
Displayed TOE	0.65	0.60	0.20	0.35
Displayed TOTAL TOE		1.25		0.55
Displayed SETBACK				
Displayed SAI				
Displayed INCLUDED ANGLE				
Displayed THRUST ANGLE			-0.10	
Raw CROSS TOE	0.34	0.06	0.11	-0.06
Raw TRACK TOE	-0.11	0.10	0.29	0.51
Raw CAMBER	1.02	0.33	-0.90	1.35
Raw SAI	3.98	-0.16	0.08	-0.12
Gain CROSS TOE	6	6	6	10
Gain TRACK TOE	3	3	21	6
Runout TOE PLANE	100.00	100.00	100.00	100.00
Runout CAMBER PLANE	100.00	100.00	100.00	100.00
Cal factor CROSS TOE	-0.05	0.02	-0.17	-0.19
Cal factor TRACK TOE	-0.06	0.03	-0.03	-0.01
Cal factor CAMBER	1.02	0.00	0.23	-0.47
Cal factor SAI	-0.31	-0.14	0.14	0.04
Head communication	GOOD	GOOD	GOOD	GOOD
Electronic turntables				
Data input				

Raw Data Display

This screen shows only the direct sensor outputs from each head. The values themselves have very little meaning when viewed while the heads are on a vehicle. All dashes showing for a head indicates a loss of communications. A loss of any toe signal will result in dashes appearing in the problem location.

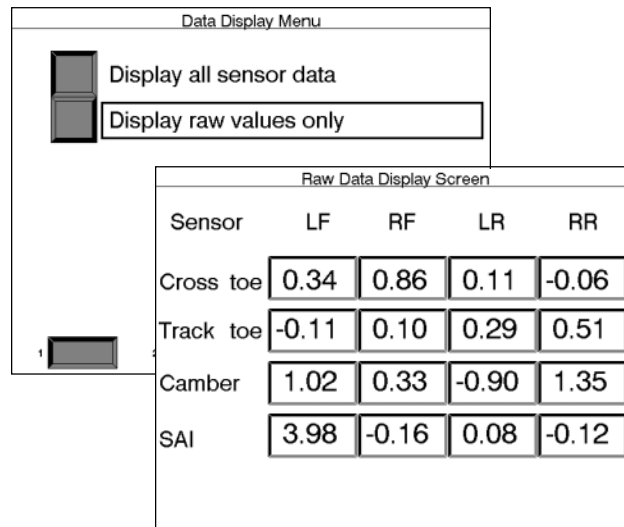

Aligner Diagnostics

Contains the following tests:

Printer test -- causes the printer (optional) to begin printing its character set. Be sure the printer is turned on before beginning this test. The printer will stop printing when it has completed its testing.

CRT adjustment -- used to maintain the VGA Monitor at peak sharpness. Adjustments to the CRT should be performed by qualified John Bean Company Service Technicians only

Head diagnostics -- reserved for John Bean Company service personnel

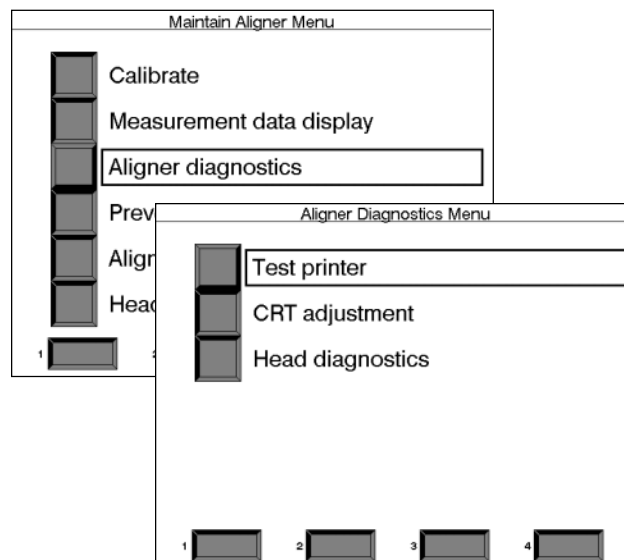

Alignment Counter (active with Suspension Plus enabled only) -- provides a count of the number of alignments performed by the Visualiner since initial installation and since the last service was performed.

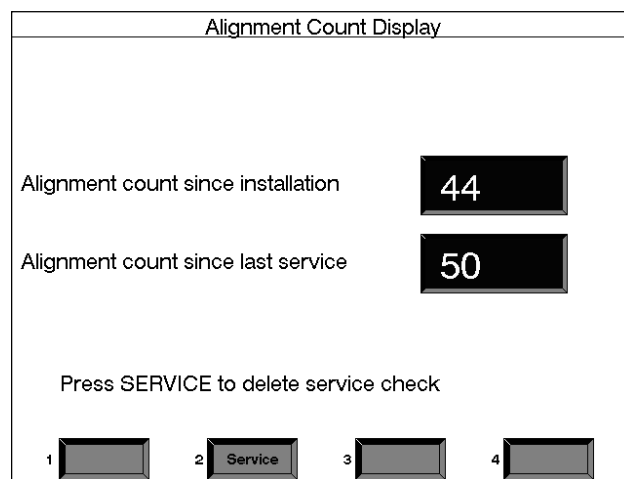

User Serviceable Parts

Many parts of the Visualiner can be replaced without calling for a Service Technician.

Cable replacement (85617): Unplug the cable from the back of the aligner and from the head. Replace with the new cable and check for proper operation.

Printer ribbon replacement: Remove the top cover of the printer and remove the old ribbon from its receptacle. Remove the protective cover from the new ribbon and position in the receptacle. Use the printer test function under the Maintain aligner menu to test the printer's operation. Read the Printer's owners manual for more details.

Membrane panel replacement (85605): Remove the four screws from the head cover. These screws are accessed through the rubber bumpers on the head cover. The membrane switch ribbon cable is attached to printed circuit board inside the head.

DO NOT PULL ON THE HEAD COVER WHEN REMOVING. DAMAGE TO THE RIBBON CABLE CONNECTOR WILL OCCUR.

Pinch the tabs on both sides of the cable connector and pull back gently on them. Slide the cable from the connector. *NOTE THE POSITION OF THE RIBBON CABLE WHEN REMOVING FOR EASIER INSTALLATION OF THE NEW MEMBRANE CABLE.* Peel the old membrane from the head cover. Clean the head cover thoroughly with Isopropyl Alcohol. When dry, peel backing off of the new membrane switch and place on head cover being careful not to pinch the ribbon cable as it passes through the hole in the cover. Place the ribbon cable back in the connector and push the connector's tabs back in. Reinstall the head cover and test the membrane for proper operation.

Other Replacement Parts

85718	Keyboard w/ decals
85569	Keyboard, no decals
85567	Remote controller
85633	Clamp wedge grip
85649	Clamp stub shaft
63499	Bungi strap
86477	Clamp rod extension
83258	Head locking knob
84467	Level - clear square
86159	Level - black round
85617	Head interconnect cable - 33'
85616	Head interconnect cable - 65'
69804	Rack to head cable - curly
86278	Rack to head cable - straight

John Bean Company would like to take this opportunity to **Thank You** for your purchase of a Visualiner Series Alignment System and sincerely hope it will bring you many years of profitable service.

Troubleshooting Operational Problems

Symptom	Possible Cause	Suggested Repair
Unit fails to turn on.	Power Supply from wall Power cable Blown Fuse	Check wall power supply by plugging in a known working item. Check the power cable for correct connection to machine. Check cable continuity or substitute known good cable. Check all three fuses located on back. If fuses are blown, check for proper voltage setting, replace. Call a qualified Technician if unit still fails to turn on.
Boot Up sequence not complete.	Program start up failure Drive failure	Switch off and turn back on. On floppy software units try with backup disk. If problem persists call a technician. Call for service.
No screen display.	Blown fuse Video card or CRT problem	Unplug unit. Check all fuses, replace if necessary. Call for service.
Error message displayed on boot Up. Program will not advance when using remote.	Program failure Computer hardware problem Remote Batteries Dead or not installed properly. Dirt on face of remote or remote sensor lens dirty or covered.	Restart unit. See above boot-up problem. If problem persists call for technician. Call for service. Check batteries. Clean remote or remote sensor lens. Call for technical support if problem persists.

Troubleshooting Operational Problems

Symptom	Possible Cause	Suggested Repair
Program will not advance when using Head or console remote. (Lock Up)	Blown Fuse Program lockup Computer hardware failure	Check fuses on rear of unit Restart aligner and retry operation. call for assistance if required. Call for service technician
Displays Head Communication Loss.	Bad Head Cable Toe PCB or computer failure	Substitute know good Head cable. Use Measurement Data Display screen. Replace bad cable. Call for service technician
Will not perform Runout.	Bad head keypad Toe PCB or computer failure	Use Measurement Data Display to read keyboard entry displays. Call for parts or for service to replace keypad. Call for service technician
Will not perform Caster Swing.	Blocked Track Toe beam Too much total toe on front wheels Unequal head heights on clamp Problem with vehicle Head component failure	Remove obstruction in toe beam path, clean lenses. Adjust total toe to straight ahead. Adjust head heights Switch to Manual Caster mode to complete, try on another car Call for service technician
Camber reading does not change and "0" Caster reading.	Broken Camber sensor Bad Toe PCB.	Call for service to replace sensor Call for service technician
Caster Adjustment reads backward from expected adjustment.	Brake pedal depressor not used or not holding brake secure. Turntables seizing	Check use of pedal depressor. Start vehicle to use power brake system. Clean, rebuild, or replace service turntables

Troubleshooting Operational Problems

Symptom	Possible Cause	Suggested Repair
"0" SAI reading after swing and no live Caster or A-arm assistance adjustment - frozen.	Broken SAI Sensor	Call for service technician
	Bad Toe PCB	Call for service technician
No Toe Readings.	Blocked Toe Beam	Remove obstruction in toe beam path, clean lenses, check for missing/cracked lenses.
	Bad LED Transmitter	Call for service technician
	Bad Toe Receiver	Call for service technician
No Printer operation	Printer unplugged or not turned on.	Check all printer power connections. Check on/off switch. Ensure Printer is "On Line" as indicated by LED.
	Printer data cable disconnected or failed.	Check connections at printer and back of computer.
	Program not configured correctly for printer or printer DIP switches not set properly.	Check system configuration under Security Code Word. If printer not enabled, call for codes. Check Printer setup also for proper configuration.
Machine resets or changes menus randomly.	Remote controller problem	Cover the Infrared receiver on the console with a cloth to see if the problem stops. If so call for check for alternate remote sources. Perhaps a TV or VCR is nearby.
	Computer system problem	Call for service technician

(Blank Page)

(Blank Page)

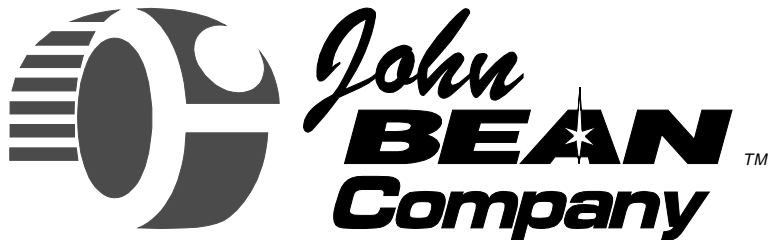
**USA**

John Bean Company
309 Exchange Avenue
Conway, Arkansas 72032
Tel.: (800) 362-8326 or (501) 450-1500
Fax: (501) 450-1585

FRANCE

John Bean Company
Snap-On Equipment France
Z.A. Du Vert Galant
15, rue de la Guivernone
BP 7175
95310 Saint Ouen L'Aumone
Tel: (33) 1-3448-5878
Fax: (33) 1-3448-5879

IRELAND

Snap-On Equipment Europe Ltd.
Bay 99
Industrial Estate,
Shannon
Co. Claire, Ireland
Tel: (353) 6147-1300
Fax: (353) 6147-2556

CANADA

John Bean Company
6500 Millcreek Drive
Mississauga, Ontario
Canada L5N 2W6
Tel: (905) 814-0114
Fax: (905) 814-0110

GERMANY

John Bean Auto Service Gerate
Division to Sun Electric Deutschland GmbH
Gewerbepark Sinn
D-35764 Sinn Herborner Str. 7-9
Tel: (49) 2772-9404-0
Fax: (49) 2772-94042-23

LATIN AMERICA

Rua Apinages
1268 cj. 605B
Perdizes-Sao Paulo-S.P.
Cep: 05017-0000
Brazil
Tel: (55) 11-871-0713
Fax: (55) 11-871-0713

Notice: The information contained in this document is subject to change without notice. **John Bean Company** makes no warranty with regard to this material. **John Bean Company** shall not be liable for errors contained herein or for incidental consequential damages in connection with furnishings, performance, or use of this material.

This document contains proprietary information which is protected by copyright and patents. All rights are reserved. No part of this document may be photocopied, reproduced, or translated without prior written consent of **John Bean Company**.

John
BEAN is a registered trademark of the John Bean Company and Snap-on Incorporated